



A150F ALUMINIUM FOLDING LIFTER

USER MANUAL



Congratulations and thank you for choosing an Aidacare Aspire A150F Folding Lifter.

This product has been designed to offer maximum safety for the user and reduced manual handling for the carer. Aidacare lifters are for Indoor use only.



IMPORTANT: Do not use the Aidacare Aspire A150F Folding Lifter without having first read this manual.



This product Features the UKCA mark, in compliance with Part II UK MDR 2002 (as amended) Class 1.



This product features the CE mark, in compliance with the Medical Devices Regulation 2002 (as amended) Class 1, and the Medical Device Regulation 2017/745

© Aidacare Limited 2024

No part of this user manual may be copied, distributed, reproduced, scanned or stored on any electronic database, whether in whole or in part in any form or by any means.

Due care has been taken to ensure all the information contained in this user manual is correct at the time of printing. All measurements, pictures, colours and weight capacities are to be used as a guide only. We reserve the right to modify the design or appearance of any product displayed in this user manual without prior notice.

TABLE OF CONTENTS

1. Symbols Used In This Manual	4
2. Symbols Used On The Product	5
3. Overview	5
4. Safety Precautions And Warnings	6
5. Intended Use	6
6. Parts Glossary	8
7. Assembly	9
8. Folding Instructions	11
9. Preliminary Checks	12
10. Lifter Operation	12
11. Lifting Guide	16
12. Sling Compatibility	20
13. Care & Maintenance	21
14. Compliance	21
15. Warranty & Service	22
16. Troubleshooting	23
17. Product Specifications	25
18. Recycling	26
19. Manufacturer, UK Representative & Import Details	27

1. SYMBOLS USED IN THIS MANUAL

The symbols below are used throughout this user manual and on the product to identify warnings and important information. It is very important for you to read them and understand them completely.



WARNING

WARNING! Indicates a potentially hazardous condition/situation. Failure to follow designated procedures can cause either personal injury, component damage or malfunction. On the product, this icon is represented as a black symbol on a white triangle with a black border.



ALWAYS! These actions should be performed as specified. Failure to perform mandatory actions can cause personal injury and/or equipment damage. On the product, this icon is represented as a white infinity symbol on a black dot with a white border.



DO NOT! These actions are prohibited. These actions should not be performed at any time or in any circumstances. Performing a prohibited action can cause personal injury and/or equipment damage. On the product, this icon is represented as a white symbol with a black circle and black slash.

2. SYMBOLS USED ON THE PRODUCT

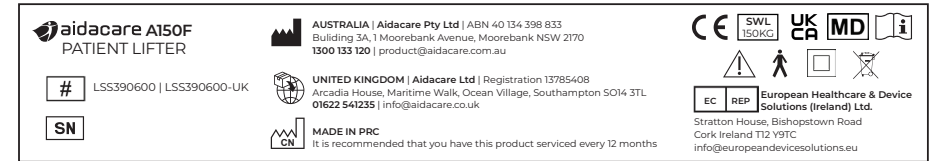

Please note: Sticker is sample only and not to scale

Product Code	UKCA Mark
Serial Number	Safe Working Load
Manufacturer	Read User Manual
Importer	Caution
Country of Manufacture	Medical Device
Class 2 Electrical Equipment	Authorised Representative in EU
Type B as per IEC60601-1	Includes Electronics components and should be mixed with General household waste
CE Mark	

3. OVERVIEW

The **Aidacare Aspire A150F Folding Lifter** is a compact and ergonomically designed heavy duty mobile patient lifter with a safe working load (SWL) of 150kg / 23.5st.

This mobile floor lifter is a safe care solution for in home care or institutional and aged care environments, and can be easily folded for transport or storage.









The A150F Folding Lifter allows patients to be transferred from floor positions, beds, chairs and other support surfaces with comfort and safety.

Despite its compact design the hinged rotating yoke on the A150F Folding Lifter generates more efficient patient space allowing a patient to be rotated through 360° at full lift height. This facilitates safe and easy transfers for both attendant and patient.

The Aidacare Aspire range of patient lifting solutions feature industry leading LINAK Jumbo Care electronics and have been designed and tested to comply with ISO 10535:2006.

4. SAFETY PRECAUTIONS AND WARNINGS

SAFETY CONSIDERATIONS

-  **ALWAYS** ensure that attendants have read this guide before operating this patient lifter.
-  **ALWAYS** use slings that are assessed and considered suitable by a trained healthcare professional.
-  **ALWAYS** ensure the area around the lifter and patient is clear of obstructions.
-  **ALWAYS** minimise the distance over which the patient is being transferred by positioning support surfaces as close as possible.
-  **DO NOT** operate the lifter without training in the safe operation of lifters and slings. **IF IN DOUBT DO NOT USE.**
-  **DO NOT** use the lifter where any doubt exists regarding the safety of the lifter including but not limited to wear or damage with particular importance to be placed on the yoke and lifter sling attachment points.
-  **DO NOT** use the lifter with slings showing any signs of wear or damage, including fraying.
-  **DO NOT** exceed the 150kg / 23.5st safe working load of the Aidacare Aspire A150F Folding Lifter.
-  **DO NOT** use the lifter as a means of transportation over distances in excess of 3 metres. It is not designed as a transportation device.

5. INTENDED USE

The A150F Folding Lifter has been designed to lift and transfer human patients with the assistance of one carer or attendant.

This product is suitable for indoor areas only and It should **NEVER** be used outdoors

All Aidacare Aspire patient lifters should **ONLY** be used with Aidacare approved patient slings, which have been chosen and assessed by a competent trained health professional. For a complete list of all compliant lifting slings please contact Aidacare.



IMPORTANT – only approved slings and accessories are compatible with this lifter. If you are unsure please contact Aidacare.

The correct and appropriate use of the A150F Folding Lifter reduces the risks associated with manual patient handling. The lifting and transferring of patients should always be assessed and planned by a trained health professional.



WARNING: DO NOT manually lift the boom of lifters.

How to Use Correctly:

The boom of the lifter is designed to be lifted only by an electric actuator.

Aidacare Lifters and Stenders do not pull downwards during lowering. This safety spline feature is designed to avoid entrapment and crush injuries.

This safety feature means that it is physically possible to raise the lifter boom by hand on some models with LA31 actuators fitted.



DO NOT raise the lifter boom by hand or any other means except under direct drive from the electric actuator fitted to the lifter.

Raising the boom can cause it to become stuck in an elevated position. Under load this can result in the patient to free fall and risks catastrophic injury to the patient and/or carer.



ALWAYS use the handset or control unit buttons to raise and lower the boom of the lifter. This will ensure correct and safe functioning at all times.



6. PARTS GLOSSARY



1	Boom	9	Push Handle
2	Quick Release Yoke Attachment	10	Lift Actuator
3	Yoke	11	Mast Height Adjustment
4	Battery	12	Base Fastening Lever Bolt
5	Control Unit	13	Manual Leg Gate
6	Emergency Lowering	14	Rear Braking Castor
7	Emergency Stop	15	Front Castor
8	Handset		

7. ASSEMBLY



1. Unpack

Remove all parts from carton.

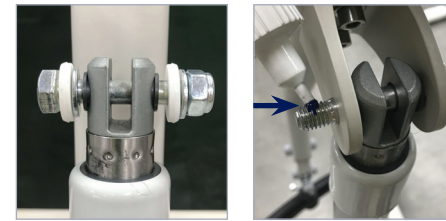

2. Apply thread locker / loctite

- Locate actuator mounting hardware.
- Install actuator hardware. A few drops of medium strength thread locker / loctite must be applied to the bolt threads.



3. Mount handle

Mount push handle onto mast in position shown and fasten screws with Allen key.



4. Attach the quick release yoke

Pull down quick release lever, engage with attachment point, release lever. Check security latch is closed.



5. Connecting the actuator

a) Connect grey actuator lead into port (1) located on base of the control unit.



b) Connect the other end into the female lead from the actuator.



6. Connecting the handset

Connect grey handset lead into port located on base of control unit.

8. FOLDING INSTRUCTIONS

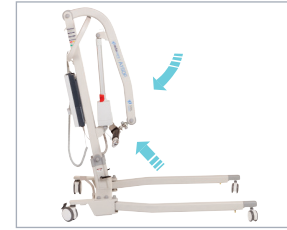

1. Bring the boom down and secure the handlebar on the wire harness.

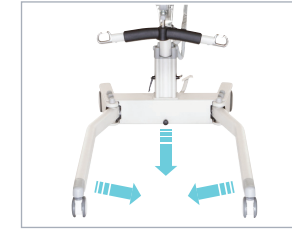

2. Pull the pin at the centre and close the legs.



3. Undo base fastening lever bolt.

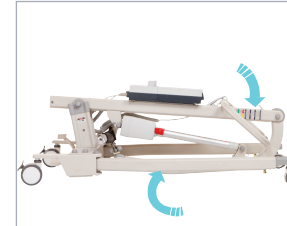

4. Fold mast down carefully and secure to legs with cords located under the end of legs.



5. Re-insert base fastening lever bolt & secure to avoid misplacing.

9. PRELIMINARY CHECKS

After charging the battery these checks should be completed prior to initially using the lifter:

1. Check handset functionality is correct.
2. Check to see that all indicator lights are functioning.
3. Check that the emergency stop button causes the lifter to stop.
4. Check emergency lowering function.
5. Check that all leads are inserted, fastened and clear of the rear castors.

10. LIFTER OPERATION

Handset

Features:

1. Raise / Lower function buttons
 2. Battery charge indicators
 3. Service indicator
- Press and hold the raise function buttons to activate. Release to deactivate. Beware of obstacles at all times to ensure boom and legs can move freely.
 - Battery charge indicators will flash when battery reaches maximum recommended discharge of 18 volts, while the lifter is under load.
 - Service indicator will illuminate when lifter has reached recommended service interval, either 12 months since last service or 8000 lift cycles. At this time the lifter needs to be serviced for safety and to maintain applicable warranty.

A full load test should be completed at least every 12 months by an Aidacare service technician.



Emergency Lowering

To activate emergency lowering lift up red tab located on top of actuator housing. This allows the patient to be fully lowered in the event of a fault in the lifter or discharged batteries.



Charging the battery

The A150F Folding Lifter is supplied with a LINAK external wall mount charger and is compatible with standard Australian power outlets.

The following steps should be completed to recharge the battery pack correctly:

- a) Remove the battery pack from the lifter via the top mounted release lever.
- b) Connect the battery pack to the charger.



Charger will automatically activate the charging sequence and a light will illuminate to show charging has commenced.

CHARGING INDICATOR DISPLAY

● **GREEN LIGHT** indicates mains power is connected to 240v power supply.

● **ORANGE LIGHT** indicates battery is charging, and will turn off automatically when battery is fully charged.

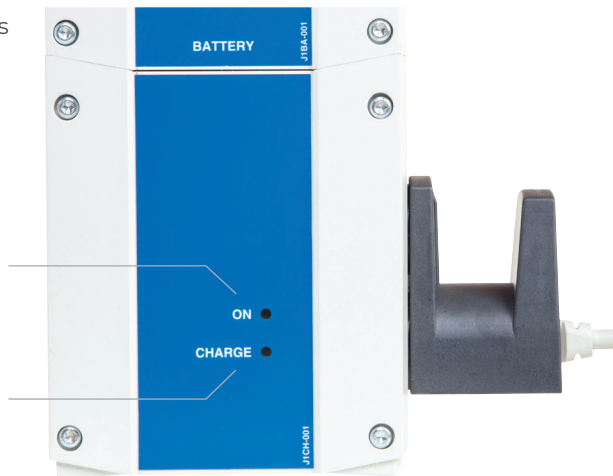

CHARGING DOS AND DON'TS



ALWAYS

- Charge the battery whenever possible, to maximise battery life. Allowing batteries to fully discharge can reduce the useful life of a battery.
- Always inspect all cables particularly the mains power cable on the charger for any damage; replace if any signs of damage or wear are visible.
- Always stow the handset, charger and mains power cable when transporting the lifter to prevent loss and or damage.
- Always clean the actuators, control box, charger, battery and handset at regular intervals to remove dust/dirt.



NEVER

- Never allow the battery to fully discharge before recharging. Allowing batteries to fully discharge can reduce the useful life of a battery.

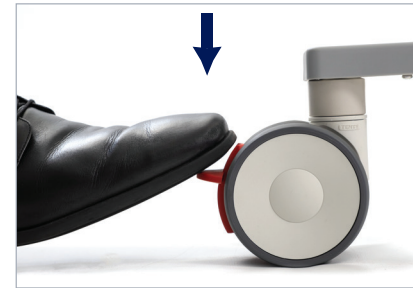

Castors

To **engage the castor brake** place your foot on the brake pedal and apply sufficient downward force to move it into the lock position.



To **disengage the castor brake** simply place the point of your toe underneath the brake pedal and lift-up.



Emergency Stop

To **engage the emergency stop** press the red button located on the control unit until it sits flush and remains in position.



To **disengage** the emergency stop function twist the red button clockwise until it pops out

11. LIFTING GUIDE

It is important that carers are familiar with manual handling techniques along with any sling instructions prior to completing any patient lifts. All patients should have the correct sling and transfer techniques assessed by a qualified health professional. Explaining the lift process to the patient is important to ensure patient comfort and confidence. It is recommended that two carers should conduct all patient lifts to ensure safe transfers.

BED

1. User sling positioning

After rolling the user on their side, position the sling along the length of the user.

Ensure that the user is positioned centrally on the sling when rolled into a supine position.



2. Attaching the sling to the yoke

The lifter should be positioned with the legs sufficiently under the bed to allow the boom and yoke to be positioned over the user's chest. Once in place, attach the loops of the sling to the hooks on the yoke.



3. Lifting the user

Before commencing, ensure that the rear castor brakes are off, so that the lifter can adjust its centre of gravity during the lift. As the straps pull tight but before the user's bottom leaves the bed, ensure the sling is positioned appropriately and that the sling loops are attached securely.

If the above sling application remains correct, the lift can be commenced. Always position the two support surfaces that the lift is taking place between as close together as possible to avoid moving the user over distances in the sling.

CHAIR

1. User sling positioning

Ensure that the user is ready, then slowly lean them forward to allow the sling to be slid down behind the back until the bottom of the sling is positioned under the coccyx.

The sling leg straps can now be slid underneath each thigh, remaining careful to avoid creasing or bunching of the fabric.



Disclaimer: For detailed full sling application instructions, please refer to the Lifter and Sling application guide by scanning the QR code





2. Attaching the sling to the yoke

Ensure that the lifter legs are open to the appropriate width and slowly position it as close to the front of the chair as possible – be careful to keep the boom and yoke clear of the user during this process.

Once the yoke is at chest height on the user the sling loops can be attached.

For chair lifts, the rear brake castors should not be used to ensure the lifter can locate its centre of gravity easily.

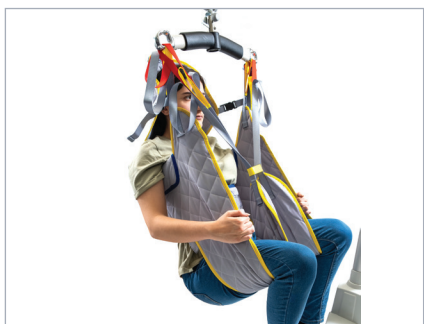

3. Lifting the user

Raise the yoke until the loops of the sling pull tight. As the straps pull tight but before the user's bottom leaves the chair, ensure the sling is positioned appropriately and that the sling loops are attached securely.

Lift the user only to a height needed to successfully transfer to the desired support surface.

Always position the two support surfaces that the lift is taking place between as close together as possible to avoid moving the user over distances in the sling.

FLOOR

Generally, a floor lift is only required in the event of a fall or emergency. Therefore, it is important that a medical professional has assessed the user and given the all clear for a lift to be carried out.



1. User Sling Positioning

After rolling the user on their side, position the sling along the full length of the user.

Ensure that the user is positioned centrally on the sling when rolled into a supine position.

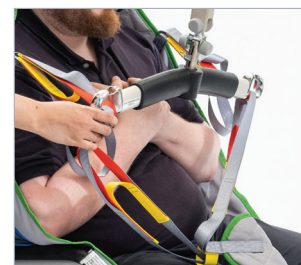

2. Attaching the sling to the yoke

The lifter should be positioned from the foot end with the lifter legs opened to ensure maximum area for the user to be lifted. The rear castors should be locked.

It is important to continually communicate with a user during floor lifts as they may often be in shock or disoriented and need reassurance.



3. Lifting the user

When carrying out a floor lift, the castors should be locked throughout the lifting procedure. As the straps pull tight but before the user leaves the floor, ensure the sling is positioned appropriately and that the sling loops are attached securely.

If the user sling position remains correct, the lift can be commenced. Lift the user only to a height needed to successfully transfer to the desired support surface.

Always position the two support surfaces that the lift is taking place between as close together as possible to avoid moving the user over distances in the sling.

12. SLING COMPATIBILITY

Aidacare has a range of Aidacare Aspire slings designed for use with the Aidacare Aspire lifters.

This lifter may also be suitable for use with other brands of slings provided that the design is compatible with a hook yoke/spreader bar design. To confirm if a sling is compatible with any of the Aidacare Aspire range of lifters, contact Aidacare.



Deluxe General Purpose



Deluxe General Purpose with Head Support



Mesh General Purpose



Mesh General Purpose with Head Support



Deluxe Access/Hygiene

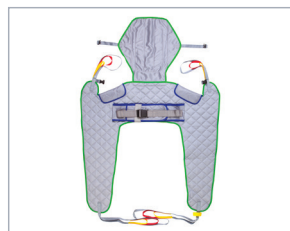

Deluxe Access/Hygiene with Head Support



Deluxe Hammock Slings
(Mesh & Super Soft Fabric Available)



Hybrid Sling



Single Use Patient Sling

13. CARE & MAINTENANCE

To prolong the working life of the lifter and for trouble free operation it is recommended that periodic inspections should be performed routinely by a person who is suitably qualified and well acquainted with the design, use and care of patient lifters.

If inspection reveals that the safety of the lifter is jeopardized in any way the lifter should be IMMEDIATELY WITHDRAWN FROM SERVICE, tagged as such and the owner notified.

COMMON CHECKS, MAINTENANCE AND CLEANING

- Check castors are fastened securely to the frame
- Castors should run and swivel smoothly – if hair or other fibres have built up within the castor this should be removed
- Check that the brakes on the rear castors function normally
- Clean surfaces with a pH neutral detergent – chlorine and phenol based detergents should not be used as these may damage lifter components
- All moving parts and pivot points should be checked for fatigue and lubricated if necessary
- All electrical components should be checked for normal function including battery and battery charger
- The actuator shaft should only be wiped with a cloth. DO NOT lubricate. Please contact Aidacare for further information.

AS A MINIMUM A FULL SERVICE SHOULD BE COMPLETED EVERY 6 MONTHS AND THE LOAD TEST EVERY 12 MONTHS TO MAINTAIN WARRANTY.

ELECTRICAL TEST & TAG – WHERE LIFTERS ARE IN USE IN A COMMERCIAL ENVIRONMENT THEN THE TESTING REGIME APPLIED SHOULD ALIGN WITH THE RISK ASSESSMENT MADE BY THE OWNER FOR SAFETY AND OTHER COMPLIANCE REQUIREMENTS.

TO MAINTAIN GLOBAL STANDARDS COMPLIANCE UNDER AS ISO 10535-2011 A FULL SWL TEST MUST BE COMPLETED EVERY 12 MONTHS.

14. COMPLIANCE

This lifter is manufactured in ISO compliant production facilities in PR China to strict quality control standards.

Aidacare Aspire lifters are manufactured and independently tested to the market relevant compliance standards.

Labels on the lifter address compliance requirements and users should familiarise themselves with these prior to use.

15. WARRANTY & SERVICE

LIFTER AND ELECTRONICS

AIDACARE warrants its products to be free from defects in materials and workmanship under normal use and service and will within the period stated below, from the date of purchase, repair or replace without cost to the original customer, any part assembly or portion thereof which shall be returned to AIDACARE and from OUR inspection shows to be defective.

1. Patient Lifter Frame – 5 years
2. LINAK Actuator and LINAK Controller – 3 years (excluding Battery Pack)
3. LINAK Battery Pack & handset – 12 month manufacturer's warranty subject to stringent fair wear and tear clauses (please contact AIDACARE for a copy of this information)

WARRANTY IS CONTINGENT UPON ANNUAL SERVICING BEING COMPLETED FOR THE LENGTH OF THE WARRANTY PERIOD.

AIDACARE cannot be held responsible for any personal injury, damage to the lifter or damage to property as a result of the improper or unsafe use of the product.

No warranty claim shall apply where the product or any part thereof has been modified, varied, altered or damaged either accidentally or through improper or negligent use.

No warranty claim shall apply where the lifter is repaired or serviced by parties other than those accredited and or approved by Aidacare.

Warranty does not extend to items or components which may require replacement due to normal wear and tear (e.g. castors, plastic molded components, foam padding (where fitted) and painted surfaces) for which AIDACARE nor its distributors can be held responsible.

BATTERIES

Batteries carry a limited warranty from the original manufacturer which is subject to a stringent wear and tear clause. Battery faults due to defect in original manufacture typically become apparent within the first two months of use.

Any gradual deterioration in performance after this period is typically associated with fair wear and tear, misuse and accidental damage, and as such is not covered by the LINAK manufacturer's warranty.

ALL WARRANTIES MADE ARE BACK TO BASE WARRANTIES MEANING THAT ANY PARTS OR WHOLE LIFTERS REQUIRING REPAIR NEED TO BE RETURNED TO THE NEAREST AIDACARE SERVICE CENTRE AT THE CUSTOMER'S EXPENSE – PLEASE CONTACT AIDACARE FOR A CURRENT LIST OF SERVICE CENTRE LOCATIONS.

SPARE PARTS

SPARE PARTS LIST AVAILABLE UPON REQUEST FROM AIDACARE

CUSTOMISATION AND MODIFICATION

All lifter customisation, modifications and or alterations made to this product are considered as “custom” changes. These may cause the product to no longer meet safety standards and should be considered prior to commencement.

Any customisation or modification of the lifter is not warranted by Aidacare and will void the warranty.

16. TROUBLESHOOTING

WARNING: TROUBLESHOOTING SHOULD ONLY BE CARRIED OUT BY AIDACARE AUTHORISED SERVICE TECHNICIANS WHO ARE TRAINED IN SERVICING THE ELECTRICAL AND MECHANICAL FEATURES OF THE PATIENT LIFTER.

The following is a guideline only to general troubleshooting.

Before carrying out any troubleshooting:

- CHECK TO ENSURE the RED emergency stop button is NOT pushed in.
- CHECK TO ENSURE maintenance procedures have been followed.
- CHECK TO ENSURE all lead connections are secure.
- CHECK TO ENSURE the battery is fully charged.

PROBLEM	POTENTIAL FAULT	ACTION
<ul style="list-style-type: none"> Warning alarm can be heard in control unit 	<ul style="list-style-type: none"> Battery is discharged Battery may be faulty 	<ul style="list-style-type: none"> Recharge battery Replace battery
<ul style="list-style-type: none"> Power LED on charger does not illuminate 	<ul style="list-style-type: none"> Not connected to power Fuse blown Faulty Charger 	<ul style="list-style-type: none"> Check plugged in to power point and switched on Replace fuse Repair or replace charger
<ul style="list-style-type: none"> Actuator not running/ no click heard from control unit when buttons pressed 	<ul style="list-style-type: none"> Faulty control unit Faulty handset 	<ul style="list-style-type: none"> Repair or replace control unit
<ul style="list-style-type: none"> Actuator not running but control unit clocks when buttons pressed 	<ul style="list-style-type: none"> Actuator plug not inserted fully into control unit Faulty actuator Faulty control unit 	<ul style="list-style-type: none"> Check plugs are completely inserted into control unit ports Repair or replace actuator and or control unit
<ul style="list-style-type: none"> Actuator not lifting properly or running slowly 	<ul style="list-style-type: none"> Discharged or faulty battery Weight in excess of safe working load (SWL) Faulty actuator 	<ul style="list-style-type: none"> Recharge or replace battery Repair or replace actuator
<ul style="list-style-type: none"> No clicking in control box when buttons pressed 	<ul style="list-style-type: none"> Emergency stop button pressed Battery completely discharged Battery fuse faulty Faulty control unit 	<ul style="list-style-type: none"> Release emergency stop button Recharge battery Repair or replace control unit
<ul style="list-style-type: none"> Actuator only works in one direction 	<ul style="list-style-type: none"> Faulty handset Faulty control unit Emergency lower release activated 	<ul style="list-style-type: none"> Repair or replace handset Repair or replace control unit Check emergency actuator release is reset

17. PRODUCT SPECIFICATIONS

Product Code	LSS390600	LSS390600-UK
Safe Working Load (SWL)	150kg	23.5st
Base Length	1280mm	50.5"
External Base Width	660-1040mm	26" – 41"
Internal Base Width	580-950mm	23" – 37.5"
Base Width Adjustment	Manual	
Base Height / Under Bed Clearance	133mm	5"
Minimum Height of Spreader Bar **	428mm	17"
Maximum Height of Spreader Bar**	1640mm	64.5"
Lifter Weight	32.9kg	73 lb
Warranty	3 Years	
Under Base Height	72mm	3"
Maximum Overall Height	1873mm	74"
Front Castor Diameter	75mm	3"
Rear Locking Castor Diameter	100mm	2"
Turning Diameter	1365mm	54"
Weight Of Heaviest Part (Base Assembly)	32.9kg	73 lb
Handle Height	1170mm	46"
Sound Level	<40Db@ 1m	
Electrical Approval	EN 60601-1-2:2007; EN 61000-3-2:2006; EN 6100-3-3:2008	

Box Contains: Base with 4 castor wheels, mast and boom with yoke, LINAK handset, LINAK battery charger, LINAK battery, LINAK controller, push handle. Screws, bolts, nuts, washers, plastic caps and tool kit.

19. MANUFACTURER, UK REPRESENTATIVE & IMPORT DETAILS

If you have any questions, you can contact:



Manufacturer:

Aidacare Pty Ltd

ABN 40 134 398 833

Building 3A, 1 Moorebank Avenue, Moorebank NSW 2170 Australia

1300 133 120 | product@aidacare.com.au



EU Representative:

European Healthcare & Device Solutions (Ireland) Ltd

Stratton House, Bishopstown Road, Cork T12 Y9TC Ireland

info@europeandevicesolutions.eu



Importer:

Aidacare Ltd

Registration 13785408

Arcadia House, Maritime Walk, Ocean Village,

Southampton SO14 3TL United Kingdom

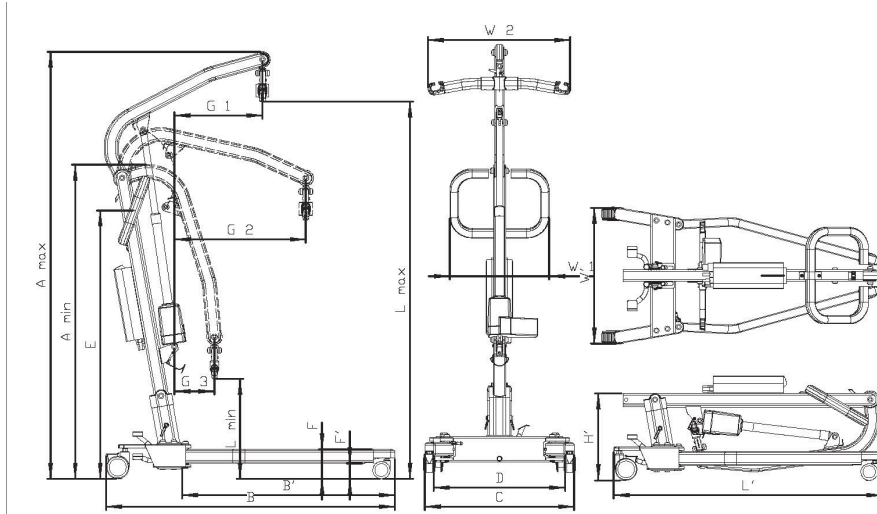

01622 541235 | info@aidacare.co.uk



Max. Load and Net Weight in kg, the rest of the measurements are in cm (unmarked tolerance +/- 1cm)																						
Item No.	Max. Load	A		B	B'	C	D	F	F'	E	G			L	W1	W2	Folding			N.W	Turning Diameter	
		Max.	Min								G1	G2	G3				L'	W'	H'			
7107	150	187.3	138.2	128	94	66-104 (tolerance +/- 2cm)	58-95 (tolerance +/- 2cm)	13.3	7.2	117	38.8 (tolerance +/- 3cm)	57.9 (tolerance +/- 3cm)	17.8 (tolerance +/- 3cm)	Max. 164	Min. 42.8	43.8	54.2	122	61.5	39.5	26.2	136.5

18. RECYCLING

This product is fitted with electronic components and should not be mixed with general household waste. Please follow the diagram below to identify materials on the product. Old batteries and electronics are to be taken to your nearest recycling centre for recycling or contact your retailer.

-  Lead Battery (Pb)
-  Waste of Electrical and Electronic Equipment (WEEE)
-  Metals

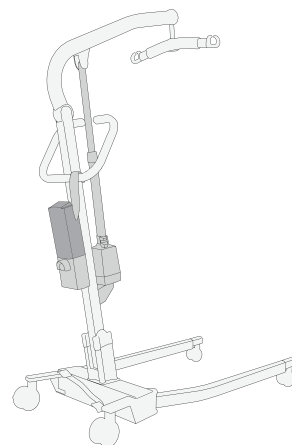

AIDACARE PTY LTD

Building 3A, 1 Moorebank Avenue,
Moorebank NSW 2170
Australia

1300 133 120 | aidacare.com.au

AIDACARE LIMITED

Arcadia House, Maritime Walk,
Ocean Village, Southampton SO14 3TL
United Kingdom

01622 541235 | aidacare.co.uk

MADE IN PRC

ABUM02.23 131223

