



COMFIMOTION

RELAX Adjustable Bed | CARE Adjustable Bed

USER MANUAL

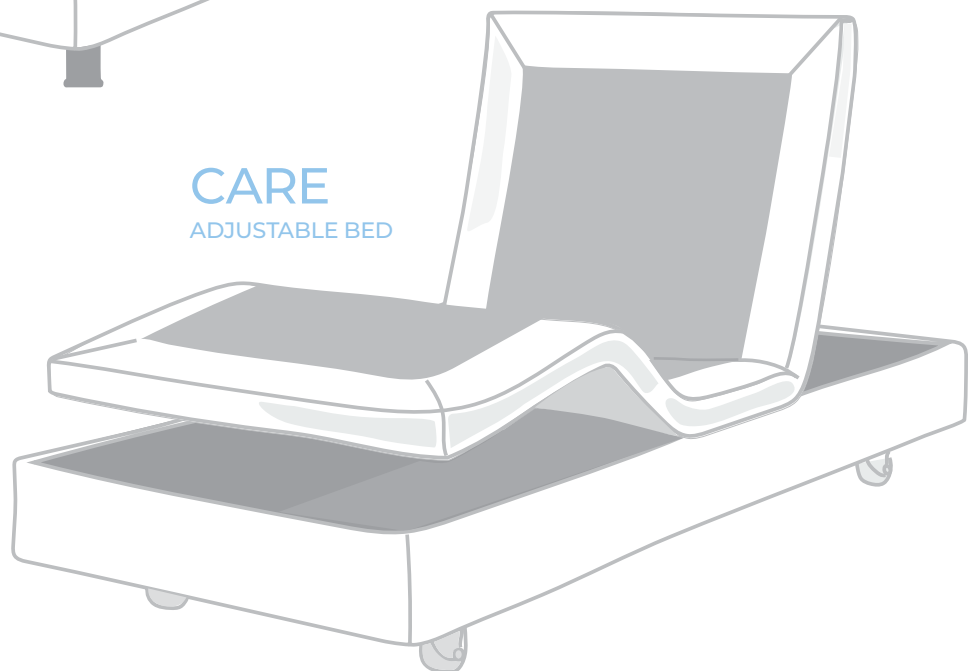

TABLE OF CONTENTS

1. SYMBOLS USED IN THIS MANUAL	5
2. INTRODUCTION	6
3. SAFETY PRECAUTIONS	7
4. SPECIFICATIONS & INCLUSIONS	9
4.1 RELAX ADJUSTABLE BED	9
4.2 CARE ADJUSTABLE BED	10
5. ACCESSORIES	11
6. HANDSET OPERATION	12
6.1 RELAX BED – WIRELESS HANDSET	13
6.2 CARE BED – WIRED HANDSET	15
7. ASSEMBLY INSTRUCTIONS	16
7.1 BEDS	17
7.2 HEADBOARDS	20
7.3 ACCESSORIES	24
8. STORAGE & MOVEMENT	27
9. CLEANING	28
10. SERVICE & MAINTENANCE	28
11. TROUBLESHOOTING	29
12. WARRANTY AND SERVICE	30
12.1 BEDS AND ACCESSORIES	30
12.2 MATTRESSES	31
13. SERVICE LOG BOOK	34

© Copyright Aidacare Pty Ltd 2022 Version 1.0

No part of this user manual may be copied, distributed, reproduced, scanned or stored on any electronic database, whether in whole or in part in any form or by any means.

Due care has been taken to ensure all the information contained in this user manual is correct at the time of printing. All measurements, pictures, colours and weight capacities are to be used as a guide only. We reserve the right to modify the design or appearance of any product displayed in this user manual without prior notice.

1. SYMBOLS USED IN THIS MANUAL



WARNING

WARNING! Indicates a potentially hazardous condition/situation. Failure to follow designated procedures can cause either personal injury, component damage or malfunction. On the product, this icon is represented as a black symbol on a white triangle with a black border.



ALWAYS! These actions should be performed as specified. Failure to perform mandatory actions can cause personal injury and/or equipment damage. On the product, this icon is represented as a white infinity symbol on a black dot with a white border.

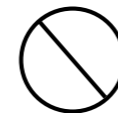

DO NOT! These actions are prohibited. These actions should not be performed at any time or in any circumstances. Performing a prohibited action can cause personal injury and/or equipment damage. On the product, this icon is represented as a white symbol with a black circle and black slash.

Thank you for choosing this
Aspire ComfiMotion Adjustable Bed.

Our ComfiMotion Collection is designed to blend
seamlessly into the home environment, whilst
improving comfort and independence.

**It is important that you read this user manual
carefully before using your new adjustable bed.**



MAX USER WEIGHT
150kg

LONG SINGLE AND KING SINGLE

MAXIMUM PATIENT WEIGHT

This weight represents the total maximum weight of a patient on the bed. This weight (150kg) should not be exceeded at any time.



SWL FOR BED
180kg

SAFE WORKING LOAD (SWL)

This weight represents the total maximum weight that the bed can carry, including patient, mattress, bedding, bed ends and accessories. This weight (180kg) should not be exceeded at any time.



MAX USER WEIGHT
310kg max for two people

LONG DOUBLE AND QUEEN

MAXIMUM PATIENT WEIGHT

This weight represents the total maximum weight of a single patient or two patients combined on the bed. This weight (310kg) should not be exceeded at any time.



SWL FOR BED
360kg

SAFE WORKING LOAD (SWL)

This weight represents the total maximum weight that the bed can carry, including patient(s), mattress, bedding, bed ends and accessories. This weight (360kg) should not be exceeded at any time.

2. INTRODUCTION

Aspire ComfiMotion Adjustable Beds are equipped with functions and features, engineered to enhance user comfort, independence and safety. Designed for easy, multi-positional operation, cleaning and serviceability, this luxurious adjustable bed collection uses premium quality materials and finishes.

MAXIMUM PATIENT WEIGHT

This weight represents the total maximum weight of a patient on the bed. This weight should not be exceeded at any time.

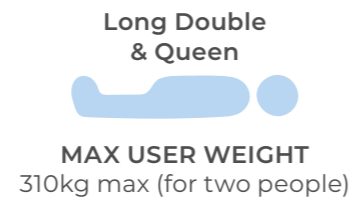

SAFE WORKING LOAD (SWL)

This weight represents the total maximum weight that the bed can carry, including patient(s), mattress, bedding, bed ends and accessories. This weight should not be exceeded at any time.

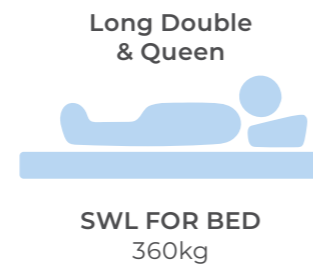
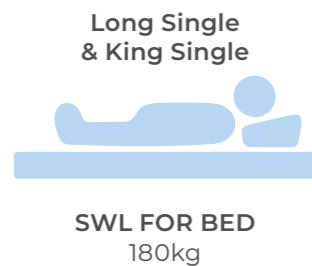

- **Night Assist:** Luminous underbed halo for safe entry and exit throughout the night.
- **Box-on-Box Design** facilitates easier entry and exit and allows true flush positioning of beds in companion or dual adjustable bed configurations.
- **German Engineered Motors** for smooth, quiet adjustment.
- **Massage:** Relaxing vibration modes for personalised neck, shoulder and back relief (**RELAX Bed Only**).
- **USB Charge:** Connect and charge your devices conveniently (**RELAX Bed Only**).
- **Press and Hold Safety Handset:** Intuitive, large button interface enhances usability.
- **Enclosed Frame Design:** Ensures optimal positioning when getting into bed and safely covers the moving base platform.
- **Safe-Lowering Technology:** Ensures that back, leg and Hi-Lo functions only lower under the force of gravity reducing potential for accidents or injuries.

3. SAFETY PRECAUTIONS

This User Manual outlines the intended use of an Aspire ComfiMotion Adjustable Bed. This constitutes how to achieve full functionality, whilst maximising the safety and efficiency of carers and users alike.

It is **IMPORTANT** that this User Manual is read in its entirety, prior to operating the bed. The manual is designed to ensure that users are equipped with all the information required to competently and responsibly operate the bed and its accessories.

It is recommended that the User Manual be kept in an easily accessible place for quick reference. If required Aidacare product specialists can provide additional training.

All warnings and cautions within this manual should be strictly adhered to. Failure to do so could result in harm to the carer or user.

WARNINGS highlighted throughout this manual identify possible hazards in procedures or conditions which if not followed correctly could result in serious injury, or fatality.

CAUTIONS highlighted throughout this manual identify possible hazards in procedures or conditions, which if not followed correctly could result in equipment damage, or failure.

GENERAL

- Electrical equipment can be hazardous if used incorrectly.
- The clinically qualified person responsible should consider the age, size and condition of the patient before using the bed and its accessories.
- The maximum safe working load of the bed is 180kg (Long Single and King Single) / 360kg (Long Double and Queen) and includes the mass of the patient, mattress and any accessories fitted to the bed.
- The maximum suggested standard mattress thickness for use with ComfiMotion Beds is 250mm.
- The bed should only be used with approved accessories. Contact Aidacare for a full list of approved accessories.
- If a patient's condition could lead to a possible entrapment the mattress support platform should be left in the flat position whilst unattended.

4. SPECIFICATIONS & INCLUSIONS

4.1 RELAX ADJUSTABLE BED

Please ensure you have familiarised yourself with the critical information below.

STANDARD RELAX INCLUSIONS:

x5  **MATTRESS RETAINERS**
4x Small (Side)
1x Long (Footend of Bed)

x1  **WIRELESS HANDSET**
See "Handset Operation"
for usability instructions

 **NIGHT ASSIST**
Underbed lighting

x4  **FIXED LEGS**

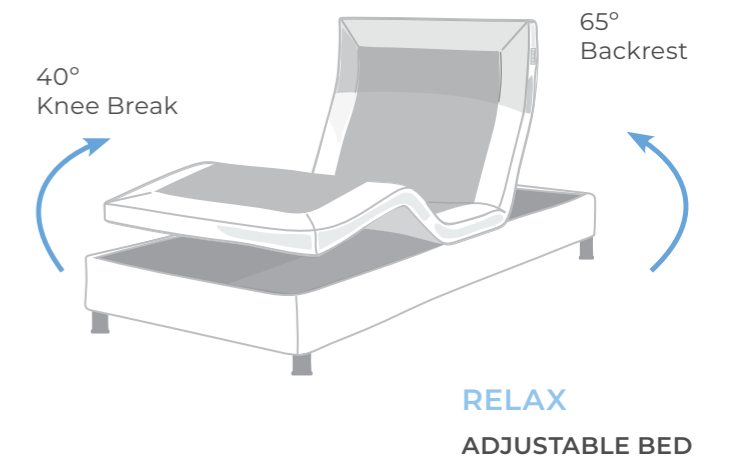



 **ALWAYS** position the bed at its lowest height when unattended to minimise the risk of patient injury from falls when getting in and out of the bed.

 **ALWAYS** use a mattress of appropriate size and type. A range of suitable mattresses are also available from Aidacare.

 **ALWAYS** make sure that the user is safely positioned to avoid entrapment before operating the bed.

 **ALWAYS** ensure that carer and user limbs are free from potential entrapment areas before operating any functions.

 **ALWAYS** apply the brakes (if castors installed) when the bed is stationary.



 **ALWAYS** store the handset when not in use to avoid accidental operation of the bed's functions.

 **DO NOT** use electrically operated beds in the presence of flammable gases.

 **DO NOT** use accessories that are not designed, or approved for use with ComfiMotion Beds.

RELAX

	OVERALL BED SIZE (L X W X H)	RECOMMENDED MATTRESS SIZE (L X W X H)
Long Single BEB046900	2030 x 920 x 280mm	2030 x 920 x 200-250mm
King Single BEB046910	2030 x 1070 x 280mm	2030 x 1070 x 200-250mm
Long Double BEB046920	2030 x 1370 x 280mm	2030 x 1370 x 200-250mm
Queen BEB046930	2030 x 1520 x 280mm	2030 x 1520 x 200-250mm

	 BED WEIGHT	 MAX USER WEIGHT	 SWL FOR BED
Long Single	55 kg	150kg	180kg
King Single	58 kg		
Long Double	62 kg	310kg (for two people)	360kg
Queen	70 kg		

4.2 CARE ADJUSTABLE BED

Please ensure you have familiarised yourself with the critical information below.

STANDARD CARE INCLUSIONS:

x5 **MATTRESS RETAINERS**
4x Small (Side)
1x Long (Footend of Bed)

x1 **HANDSET**
See "Handset Operation"
for usability instructions

NIGHT ASSIST
Underbed lighting

x4 **LOW-PROFILE FIXED LEGS**
Kit includes four legs
and is available upon
request (GSP640100)

x4 **75MM CASTORS**
(Optional 125mm Accessibility
castors are required for patient
lifter or overbed table access)
MWT451080 (4x required)

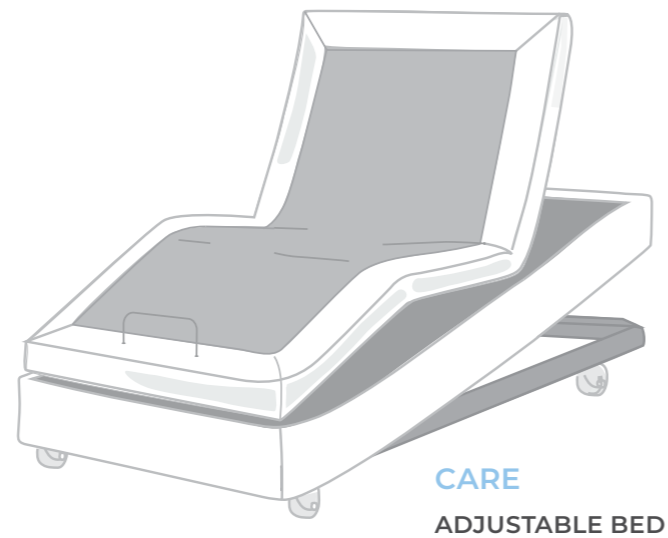

CARE
ADJUSTABLE BED

	OVERALL BED SIZE (L X W)	HEIGHT RANGE DIFFERENT LEG OPTIONS (H)		RECOMMENDED MATTRESS SIZE (L X W X H)
		Low-Profile Fixed Legs	75mm (Standard) Castors	
LONG SINGLE BEB046720	2030 x 920mm	280 – 580mm	350 – 650mm	2030 x 920 x 200-250mm
		350 – 650mm	400 – 700mm	
		400 – 700mm		
KING SINGLE BEB046730	2030 x 1070mm	280 – 580mm	350 – 650mm	2030 x 1070 x 200 – 250mm
		350 – 650mm	400 – 700mm	
		400 – 700mm		

	KG BED WEIGHT	MAX USER WEIGHT	SWL FOR BED
Long Single	90 kg	150kg	180kg
King Single	100 kg		

*Increases underbed clearance to accommodate most patient lifters.

5. ACCESSORIES

A range of ComfiMotion Bed accessories are available. In addition to the below listed accessories, Aidacare specialises in other complimentary products such as foam mattresses, pressure care surfaces, over bed tables, side lockers and adjustable day chairs. Please contact Customer Service on 1300 133 120 for further information.

CODE	DESCRIPTION	IMAGE
Long Single – BEA830120 King Single – BEA830130 Long Double – BEB830132 Queen – BEB830134 King – BEB830136	Allure Headboard	
Long Single – BEA830100 King Single – BEA830110 Long Double – BEB830112 Queen – BEB830114 King – BEB830116	Chesterfield Headboard	
BEA830200	Crook Handle Bed Stick	
BEA830210	Bed Rail	
BEA824200	Aspire ComfiMotion Transport Trolley	
MWT451080 (4 x required)	Larger Castors	
BEA830220	Battery Back Up	



DO NOT use accessories that have not been designed for use with ComfiMotion Beds.

WARNING

FIXED COMPANION BED LEGS

Kit available for ComfiMotion FIXED COMPANION beds to achieve a 350mm bed height (same height as the Adjustable Beds with standard castors). Kit can also be used on a ComfiMotion Adjustable Bed to increase the overall bed height. (GSP640105).

6. HANDSET OPERATION

PLEASE READ THE CRITICAL INFORMATION BELOW:



WARNING

- Ensure the user, carer and/or equipment is positioned to avoid being trapped or crushed during bed adjustment.
- Ensure the handset cord is not stretched excessively (**CARE Bed Only**).
- Ensure the handset and electrical leads cannot become entangled with moving parts of the bed.
- **DISCONNECT** the power lead from the mains and stow before transporting the bed.
- If the power lead shows any sign of damage, replace immediately.

RELAX BED – WIRELESS

Handset requires pairing via sync



CARE BED – WIRED

Handset requires simple cord setup

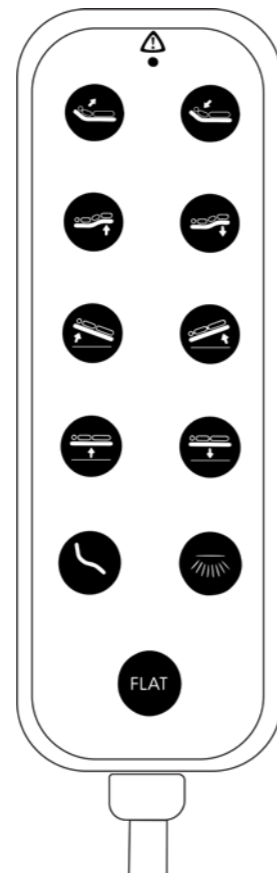

IMPORTANT INFO – (RELAX & CARE)



WARNING

Extra care should be taken whilst operating the bed functions to ensure hands and fingers are free from potential squeeze hazards.

USING YOUR HANDSET



Press & Hold to initiate function
Release button to stop

6.1 RELAX BED – WIRELESS HANDSET

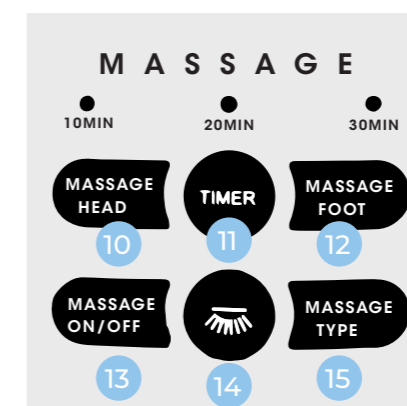
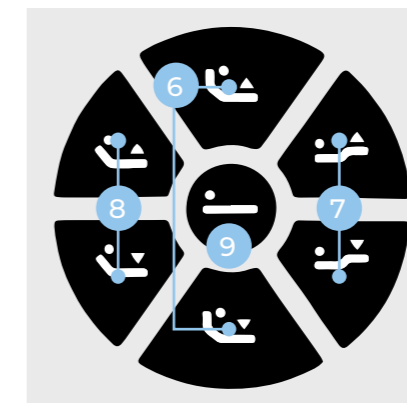
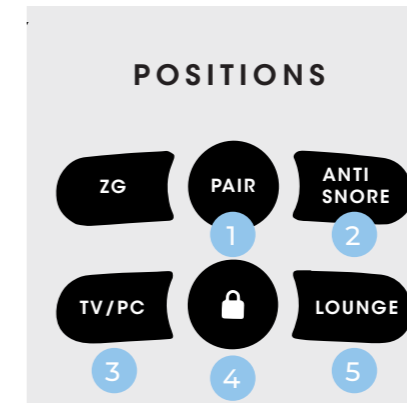

- 1 Pair Handset
- 2 Anti Snore
10° Backrest
- 3 TV / PC Mode
65° Backrest
+ 15° Leg Raise
- 4 Lock & Unlock
- 5 Lounge Mode
30° Backrest
+ 10° Leg Raise
- 6 Headrest Tilt
Forwards & Backwards
- 7 Legrest
Up & Down
- 8 Backrest
Forwards & Backwards
- 9 Flat / Sleep Mode
Resets to Neutral
- 10 Head Massage
- 11 Message Timer
10 / 20 / 30 minutes
- 12 Foot Massage
- 13 Massage On / Off
- 14 Night Assist
Underbed Lighting
- 15 Message Intensity
3 Types

USING YOUR HANDSET



Press & Hold to initiate function
Release button to stop

*NOTE: If handset unpairs from the bed at any stage, please refer to 'PAIR' instructions above.

1. **Pair***: Handsets come pre-paired in the box however if you replace your handset, see below instructions on how to pair your new handset to your bed: **On the control box**, double click the 'PAIR' button until the LED illuminates. **On the handset**, press and hold the button until the 'BLUE' LED changes to 'GREEN'.
NOTE: If this does not occur within 10secs, repeat above steps.
2. **Anti-Snore**: Slight elevation of backrest (10°) to help ease symptoms of respiratory conditions, when sleeping.
3. **TV/PC Mode**: Simultaneously raises the backrest (65°) and legrest (15°), ideal for watching TV or using smart devices.
4. **Lock & Unlock**: To lock all functions, *PRESS & HOLD* until button flashes red. To UNLOCK, *PRESS & HOLD* for 5secs.
5. **Lounge Mode**: Simultaneously raises the backrest (30°) and legrest (10°) to maximise comfort and relaxation.
6. **Headrest Tilt**: Adjusts the headrest between 65 – 85°. This can help alleviate neck muscle strain, providing optimal support while reading or watching TV.
7. **Legrest**: Adjust the legrest to promote better circulation, relieving tired, swollen and/or painful limbs.
8. **Backrest**: Adjusts the backrest (up to 65°) providing postural support, easing symptoms of reflux, respiratory conditions, snoring and sleep apnoea.

9. **Flat / Sleep Mode**: Resets to a neutral flat position, simultaneously lowering the bed to the minimum height.
10. **Head Massage**: Activates the headrest massage function.
11. **Massage Timer**: Allows users to nominate how long they will the massage to operate for at 10, 20 or 30min intervals.
12. **Foot Massage**: Activates the foot section massage function.
13. **Massage On / Off**: Switches the massage function 'ON' and 'OFF'. **NOTE:** Massage ON/OFF must be pressed prior to using any of the massage functions.
14. **Night Assist**: Luminous underbed halo (lighting) for safe bed entry and exit throughout the night.
15. **Massage Intensity**: Choose between three different types of massage intensities.

6.2 CARE BED – WIRED HANDSET



6.2.1 SETTING UP YOUR CARE HANDSET

To connect the handset: Insert and secure the handset cable into the port labelled 'HANDSET' (located in the control box underneath the bed).

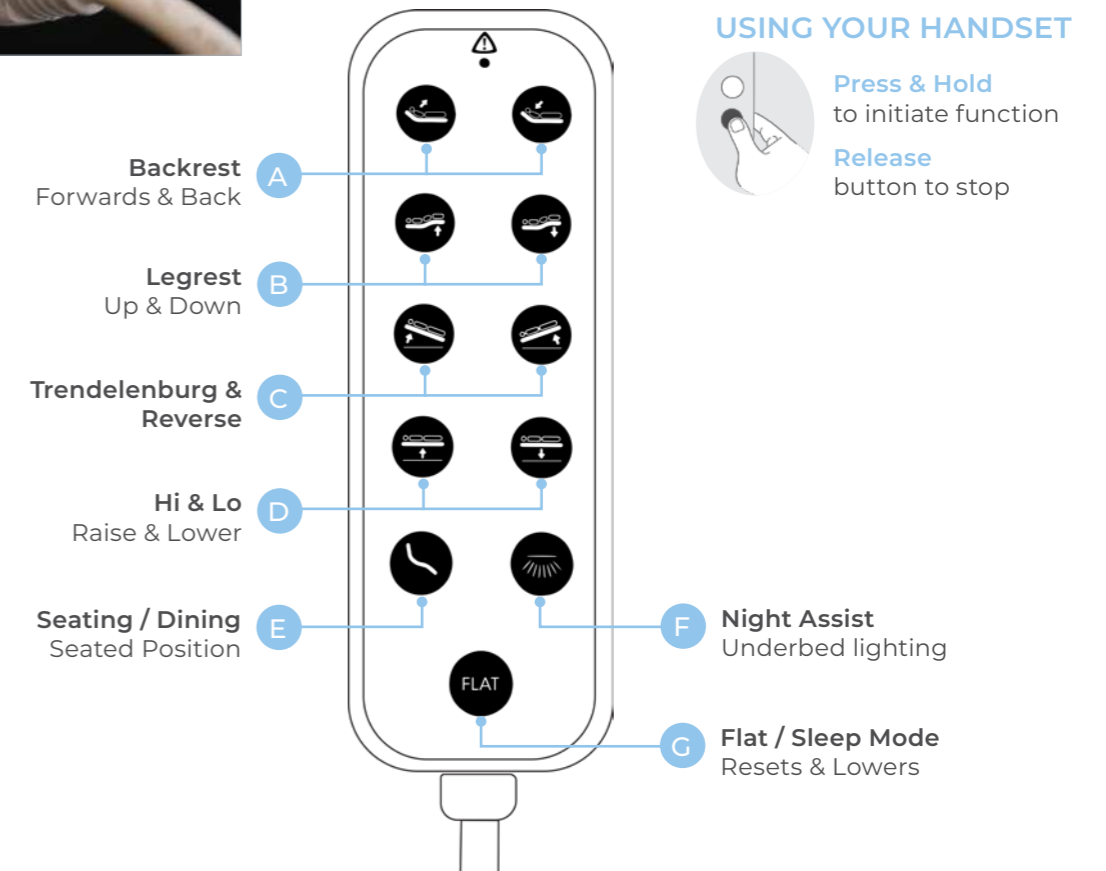

- A. **Backrest**: Adjusts the backrest (up to 65°) providing postural support, easing symptoms of reflux, respiratory conditions, snoring and sleep apnoea.
- B. **Legrest**: Adjust the legrest to promote better circulation, relieving tired, swollen and/or painful limbs.
- C. **Trendelenburg (-12°) and Reverse (12°)**: This position helps facilitate blood pressure localisation as well as promote low cardiac output. This medically prescribed position is not recommended for those with heart issues or those susceptible to strokes.

- D. **Hi / Lo**: Raise and lowers the height of the bed. Consider lowering the bed to assist with manual handling and help mitigate falls risk.
- E. **Seating and Dining**: Bed transforms into a seated position, ideal for upright dining as well as bed entry and exit.
- F. **Night Assist**: Luminous underbed halo (lighting) for safe bed entry and exit throughout the night.
- G. **Flat / Sleep Mode**: Resets to a neutral flat position, simultaneously lowering the bed to the minimum height.

7. ASSEMBLY INSTRUCTIONS

GETTING STARTED

ComfiMotion Beds come securely packaged in a cardboard carton. Inside the carton you will find the castors, retainers and hand control safely secured underneath the bed frame. The entire bed is also wrapped for further protection. ComfiMotion Beds should arrive to you in pristine condition, ready for immediate assembly and installation.

TOOLS REQUIRED



TIPS For easy installation we recommend using the ComfiMotion Bed Moving Trolley.

CARTON CONTENTS:

- 1 x ComfiMotion Bed (CARE or RELAX)
- 1 x Handset
- 1 x Headboard (Sold Separately)
- 4 x 75mm Locking Castors (CARE)
- 4 x Bed Legs (RELAX)
- 4 x Side Mattress Retainers and Hardware
- 1 x Foot End Mattress Retainer



ComfiMotion Beds are a large piece of equipment requiring special attention and careful handling at all times.



When opening the carton, ensure it is done in a safe and careful manner. **DO NOT USE** a box cutter or sharp implement down the centre of the carton as this may damage the product.

7.1 BEDS

HOW TO UNPACK & INSTALL

RELAX / CARE Beds

- 1 Remove bed from carton and position on flat surface or a Bed Moving Trolley for easy setup. Ensure the bed is placed **TOP DOWN**, so all components (hand control, retainers, castors & power cord) can be removed easily from the underside of bed.



DO NOT USE a box cutter, Stanley knife or sharp implement when opening the carton. Doing so may cause irreversible damage to the product and void warranty.

- 2 Using a box cutter, unhook all components from the base of the bed (retainers, power cord, hand control and castors).

Retainers

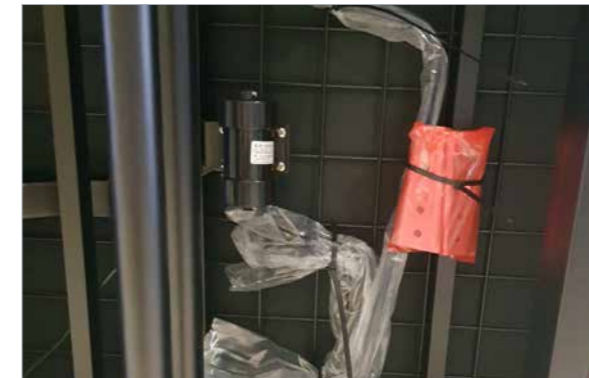

Hand Control



Castors or Bed Legs

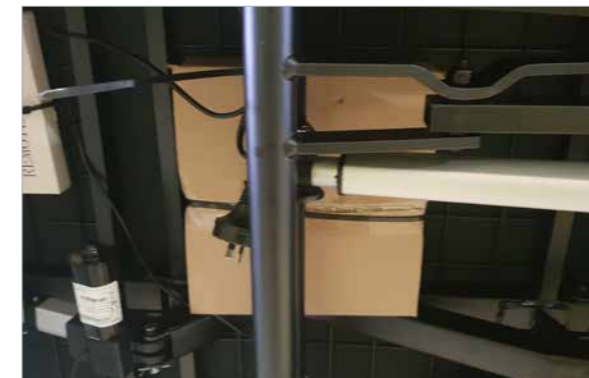

Power Cord



7.1.1 LEG TYPE

HOW TO FIT

Legs / Castors

- 3 **IMPORTANT!** The leg or castor selection (a, b, or c) will determine the minimum bed base height (not including the mattress).

IMPORTANT! Beds should remain on their side when installing the legs or castors.



2 X PEOPLE REQUIRED: We strongly recommend having an additional person to hold the bed frame whilst installing the legs or castors to avoid tipping.



a) Standard or Low Profile Bed Legs



- i. Insert the protruding stem into the hole located at each corner of the bed.
- ii. Fasten by hand and tighten with spanner. Repeat for each leg.



b) Standard Castors



- i. Insert the protruding castor stem into the hole located at each corner of the bed.
- ii. Fasten by hand and tighten with spanner. Repeat for each castor.



c) Accessibility Castors

- i. Insert the protruding castor stem into the hole located at each corner of the bed.



- i. Fasten using an 8mm Allen Key. Repeat for each castor.



- 4 Connect hand control into control box port (**CARE bed only**).



NOTE: RELAX Bed has a wireless hand control, no need to connect to Control Box.

- 5 Cut safety securing straps that hold the bed in place when in carton.

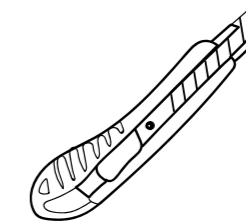

- 6 Turn bed FACE UP, secure 4 x mattress retainers (side) and 1 x mattress retainer (foot) in place by pushing into allocated slots. Finally, place the mattress onto the bed ensuring all mattress retainers hug the sides and footend.

Side Mattress Retainer



Foot End Retainer

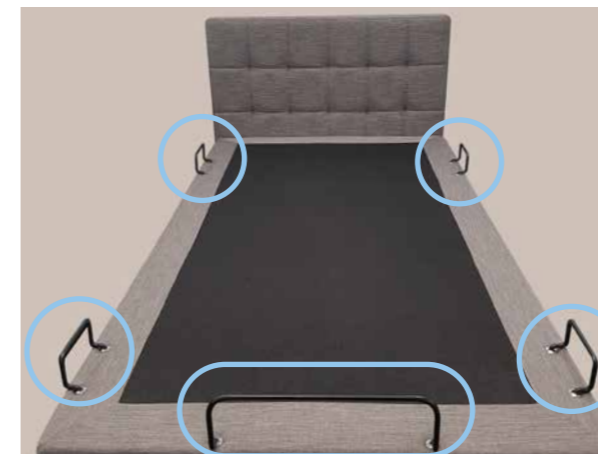

7.2 HEADBOARDS

HOW TO ASSEMBLE OR MOUNT

Allure / Chesterfield Headboards

Headboards	Allure	Chesterfield
	BEA830120 – Long Single	BEA830100 – Long Single
	BEA830130 – King Single	BEA830110 – King Single
	BEA830132 – Long Double	BEA830112 – Long Double
	BEA830134 – Queen	BEA830114 – Queen
	BEA830136 – King	BEA830116 – King

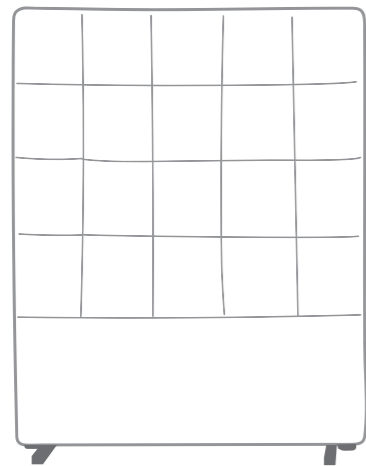

ALLURE HEADBOARD

OR

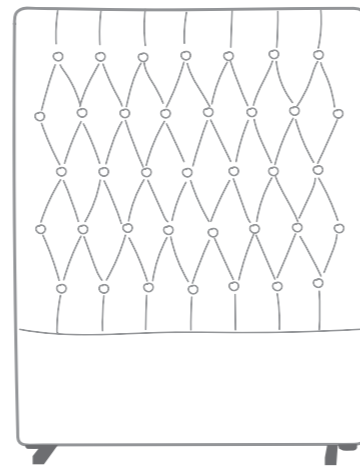

CHESTERFIELD HEADBOARD

2 X OPTIONS TO FIT HEADBOARDS

OPTION 1

FREESTANDING (WITH STABILISERS)

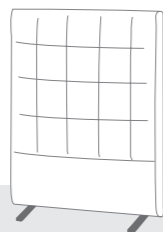

- For use on the:
- ✓ RELAX BED
 - ✓ CARE BED
 - ✓ FIXED COMPANION BED

OPTION 2

MOUNTED TO BED BASE

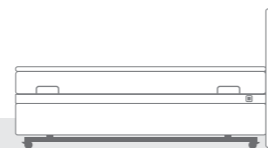

- For use on the:
- ✓ RELAX BED
 - ✗ CARE BED
 - ✗ FIXED COMPANION BED

7.2.1 OPTION 1

HOW TO ASSEMBLE – FREESTANDING WITH STABILISERS

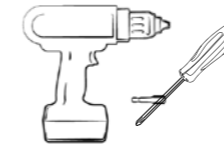

TOOLS REQUIRED:

- Impact driver or drill (5mm attachment)
- Phillips head screw driver (5mm)

For use on the:

- ✓ RELAX BED
- ✓ CARE BED
- ✓ FIXED COMPANION BED

1 Flip headboard upside-down to show the black upholstery.

2 Using the leg stabiliser, align the holes to the white markings.

NOTE: The short end of the stabiliser should face the back of the headboard (the side that will be positioned against the wall).



3 Secure the stabilisers in place using the screws provided.



4 Finally, flip the headboard back to its original position, enabling it to stand freely.



TOP VIEW

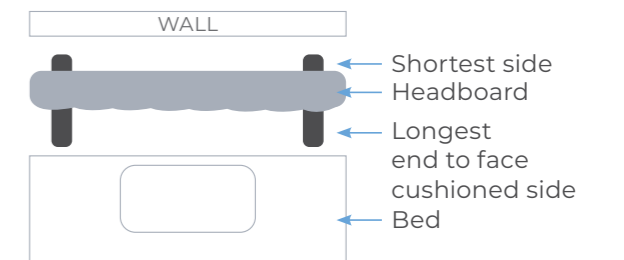

7.2.2 OPTION 2

HOW TO MOUNT TO BED

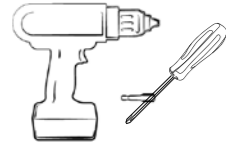

TOOLS REQUIRED:

- Impact driver or drill (5mm attachment)
- Phillips head screw driver (5mm)

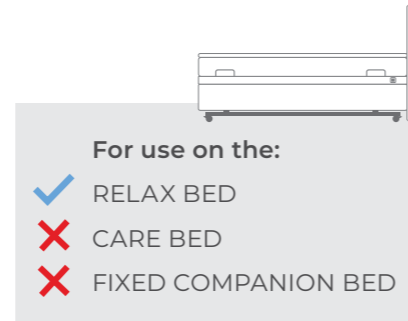

NOTE: It is suggested that an impact driver or drill is used to speed up this process. Using a Phillips head screwdriver will work but will take more time. If the impact Driver/Drill has a clutch setting, it should be set to low torque to minimise any risk of bolt misalignment or mount point damage.

NOTE: Headboards can be mounted to the **RELAX Bed only**.

- 1 Raise bed height, backrest and knee break to maximum height for ease of access.

RELAX HANDSET



BACKREST

Raise to Max.



LEGREST

Raise to Max.



- 2 Locate mounting holes for screw insertion. To locate holes:

- a. Locate threaded mounting holes (2 per side) at head end of bed.
- b. Line up bracket over threaded mounting holes and mount in place by rotating Phillips head bolt through the top and bottom mounting holes.
- c. Repeat on both sides, ensuring 4 x bolts (2 per side) are fastened in place.



- 3 When mounting brackets to bed end:

- a. Line bracket up with foot stopper (on base of headboard).
 - i. Ensure bracket is spaced approx. 40mm from edge of headboard.
 - ii. Ensure bracket is spaced approx. 60mm from base of headboard.
- b. Through rotation the screw will pierce through the fabric and thread into wood frame (self-tap). Repeat on both sides, ensuring 8x screws (4 per side) are fastened in place.
- c. Using an impact driver, rotate screw through the upholstery inwards towards frame.
- d. **NOTE:** Position of bracket should be as per measurements otherwise it will not fit securely to the bed frame.



- 4 Align bracket fixings (headboard bracket will slide into bed frame bracket), Slide headboard down until both brackets click into place, the headboard is now in place.

NOTE: Headboard foot supports will rest on the ground when in lowest height.



7.3 ACCESSORIES

HOW TO FIT TO BED

Bed Rail / Bed Stick

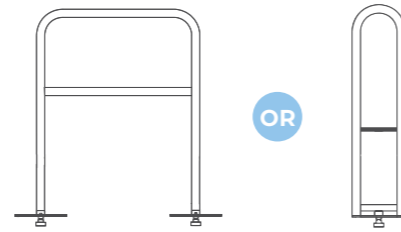

ACCESSORIES	BED RAIL BEA830210	CROOK HANDLE BEA830200
-------------	--------------------	------------------------

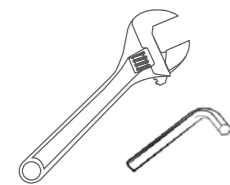

For further installation and operating instructions, refer to the User Manual.

TOOLS REQUIRED:

- Allen Key (5mm)
- Adjustable Shifter/Spanner

KIT CONTENTS

Bed Rail

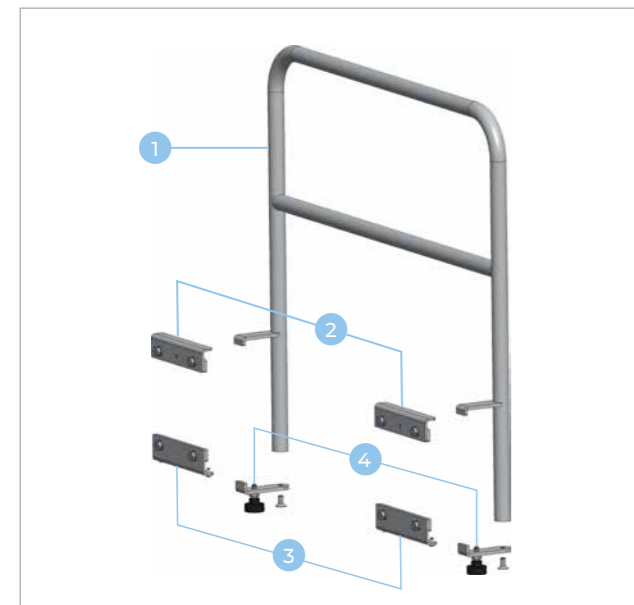

Crook Handle



ITEM	QTY (BED RAIL)	QTY (CROOK HANDLE)	DESCRIPTION
1	1	1	Rail
2	2	1	Top Guide Rail
3	2	1	Bottom Guide Rail
4	2	1	Mounting Plate
5	2	1	Hand Bolts
6	8	4	M8 x 20 Bolts
7	8	4	M8 Washers
8	4	2	M5 x 10 Bolts
9	2	2	M8 x 16 Countersunk Bolts

NOTE: Some items not shown in images above

- 1 Raise bed height, backrest and knee break to maximum height for ease of access.

To adjust:

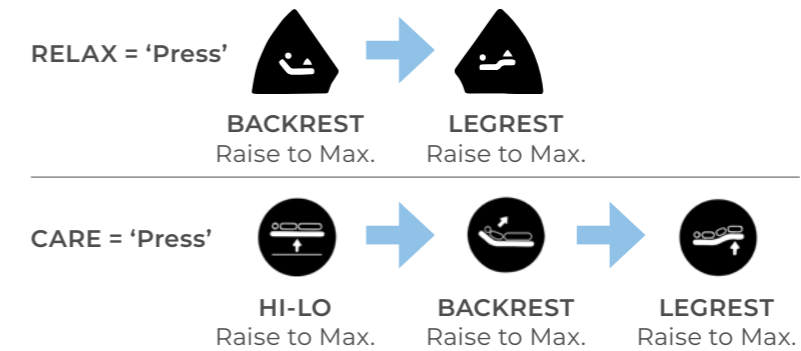

- 2 ComfiMotion beds have pre-installed mounting points for accessories.

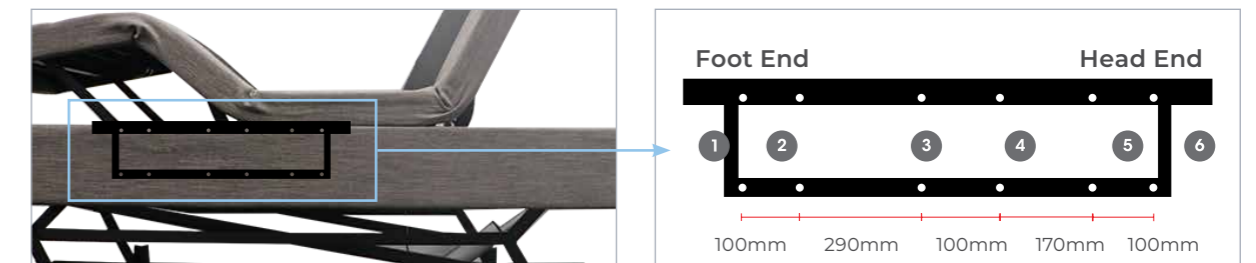

NOTE: Frame not visible through upholstery, for instructional purposes only.

To install **bed rail (BEA830210)** – use positions 1, 2 and 5, 6.

To install **crook handle (BEA830200)** – use positions 3 and 4.

- 3 Assemble the top 2 and bottom 3 guide rail(s) onto the frame using the M8 x 20 bolts 6 and washers 7.

Bed Rail



Crook Handle



8. STORAGE & MOVEMENT

- 4 Slide the rail 1 between the mattress deck and frame and slide into the top guide rail(s). Slide the mounting plate(s) 3 into the bottom guide rail(s).

Bed Rail



Crook Handle



- 5 Attach the rail 1 and mounting plate(s) 3 using the M8 x 16 countersunk bolts 9.

- 6 Adjust the rail 1 within the rails to desired position. Once in place, lock in place by tightening the hand bolt(s) 5.



WARNING

- **DISCONNECT** the bed power cord before moving the bed.
- **DO NOT** remove the power cord from the source by pulling on the cord.
- **DO NOT** pull on the power cord, or handset cord to manoeuvre the bed.
- **ALWAYS APPLY THE BRAKES** when the bed is in a stationary position.

HANDLE WITH CARE

- ComfiMotion Beds should be stored in a clean, dry, well ventilated area.
- Do not drop and avoid shock or violent impact when transporting.
- Aidacare offers many bed moving trolley options, please contact us for further information on 1300 133 120 or visit our website at aidacare.com.au.

COMFIMOTION COMPACT TRANSPORT TROLLEY

Bed frame mechanisms arrive in the box secured with fasteners to minimise loading difficulty and centralise the bed centre of gravity for loading.

KEY FEATURES

- **Tight Turning Radius:** Short wheel base with large low resistance castors make manoeuvring through tight spaces manageable.
- **Reduce Stock Damage:** Padded trolley surfaces protect the fragile upholstery of the bed surround, reducing damage during freight and handling.
- **WHS Outcomes:** Safety strap and lockable castors make loading and unloading the trolley a simple process.

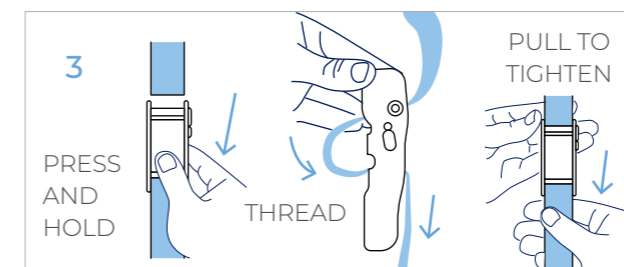
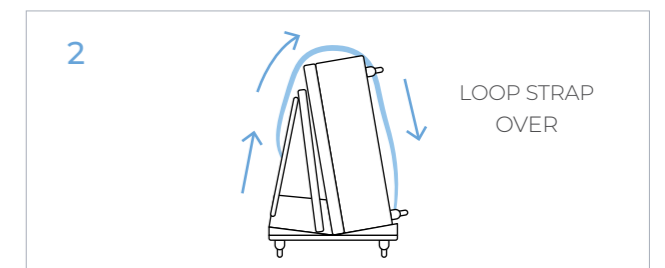
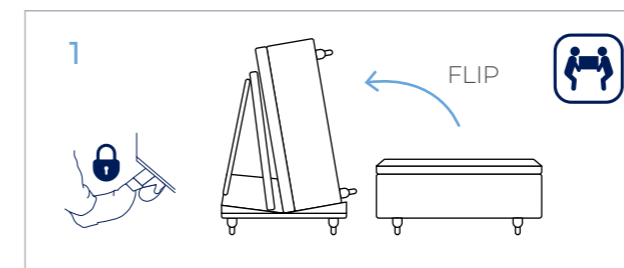

9. CLEANING



WARNING

Before cleaning always disconnect the bed from the mains power source.

NOTE: It is strongly recommended that protective clothing be used when cleaning.

NOTE: The following procedure also applies to bed accessories, but does not include mattresses.

- Wipe the beds surfaces with a soft cloth moistened with hot water and mild detergent.
- Rinse with clean water and dry with a clean cloth.
- Ensure bed upholstery is only lightly wiped, it is important not to leave this wet after cleaning.

Allow the cleaned parts to dry before replacing the mattress.



WARNING

DO NOT clean with bleach!

10. SERVICE & MAINTENANCE

To prolong the working life of the bed and for trouble free operation it is recommended that routine inspections should be performed by a person who is suitably qualified and well acquainted with the design, use and care of ComfiMotion beds.

If inspection reveals that the safety of the bed is jeopardised in any way, it should be **IMMEDIATELY WITHDRAWN FROM SERVICE**, tagged as such and the owner notified, until repair or replacement has occurred.

INSPECTION:

- A visual and functional inspection should be performed monthly
- Visually inspect electrical components: can you see damage to the hand control or power cord?
- Visually inspect mechanical components: can you see damage, chips or deformation to the frame, headboard or accessories?
- Is the hand control functioning as it should?
- Are the castors, brakes and accessories functioning as they should?

PREVENTATIVE MAINTENANCE:

The following preventative maintenance procedures should be carried out every 12 months or as otherwise specified:

NOTE: Other than general maintenance activities all other service or repair work must be performed by qualified and trained persons or agents approved by Aidacare.

- Overall functional check that all hand control functions are operating the bed as expected.
- Overall inspection for visible signs of wear, tear or damage to the integrity of electronics and cables.
- Actuators and all moving components should not make unusual noises.

NOTE: If you are unsure if your ComfiMotion bed is working correctly, Contact Aidacare or your local authorised Aspire Dealer.

11. TROUBLESHOOTING

EFFECT	POSSIBLE CAUSE	VERIFICATION	CORRECTIVE ACTION
Bed does not stay in place	Locking castors not preventing bed movement. Brake System is malfunctioning.	Not all locking castors have been engaged. Brake pedal is in lowest position, but bed does not stay in place.	Engage all 4 x locking castors on each corner of the bed. If this does not work, contact your sales representative or a qualified Aidacare service technician.
Bed does not move up or down	Bed is not plugged in and optional battery is flat. Actuator is faulty. Handset is faulty.	Check if the power lead is plugged into mains power. Swap actuators. Swap handsets.	If unplugged, plug power leads into mains power. Allow 3 hours to charge battery (if fitted). Contact your sales representative or a qualified Aidacare service technician.
Backrest does not move up or down	Actuator code is unplugged. Actuator is faulty. Handset is faulty.	Check if cables have come loose from control box (under top frame at head end). Swap actuator. Swap handsets.	If loose, fully plug cables into control box. Contact your sales representative or a qualified Aidacare service technician.

12. WARRANTY AND SERVICE

12.1 BEDS AND ACCESSORIES

Congratulations on the recent purchase of your Aspire ComfiMotion bed, mattress and/or accessories. ComfiMotion beds and accessories carry a comprehensive warranty as detailed below (see 12.2 Mattresses for mattress warranty information). Please keep proof of purchase for proof of warranty commencement.

BEDS

RELAX MODELS CARE MODELS	10 Years Warranty	Frame
	2 Years Warranty	Electronics
	1 Year Warranty	Handset, Cables And Fabric
FIXED COMPANION	10 Years Warranty	Frame
	1 Year Warranty	Fabric

ACCESSORIES

BED RAIL – BEA830210 CROOK HANDLE – BEA830200	5 Years Warranty	
HEADBOARDS	1 Year Warranty	Chesterfield + Allure

PILLOWS

BREEZE – BEP050100	1 Year Warranty	
PLUSH – BEP050110	1 Year Warranty	

MATTRESSES*

MEMORY FOAM	10 Years Limited Warranty	
POCKET SPRING	5 Years Limited Warranty	

*More details on next page.

CONSUMER WARRANTY AGAINST DEFECTS:

Aidacare is bound by Australian Consumer Law in respect to Warranty Against Defects. A copy of the Aidacare Warranty Against Defects statement is available on the Aidacare homepage at aidacare.com.au. All warranty matters should be directed to Aidacare Customer Service on 1300 133 120.

Aidacare does not warrant against excessive or incorrect use, modification or any situation that could not be deemed as fair wear and tear. This is a back to base warranty and does not cover freight costs pertaining to the return of any items under warranty. Aidacare acknowledges and conforms to all ACCC guidelines around consumer rights. For further information contact Aidacare on 1300 133 120 or email product@aidacare.com.au

Aidacare will not warrant the safety and or correct functioning of products where any original components have been changed or modified by non-Aidacare approved and trained service & maintenance staff or external providers. Furthermore, safety is not guaranteed where components have been replaced with non-original Aidacare approved parts. If any faults are detected upon receipt of this product please phone Aidacare. Any faults that are detected during normal use should be reported to Aidacare immediately to determine if warranty conditions apply and if so, the necessary repair or replacement work to be completed.

Spare parts list is available upon request.

For servicing, preventative maintenance and any other questions regarding this or any other Aidacare product please contact:

Aidacare Pty Ltd
Building 3A, 1 Moorebank Avenue
Moorebank NSW, Australia 2170

T: 1300 133 120 | W: aidacare.com.au | E: product@aidacare.com.au

12.2 MATTRESSES

ComfiMotion Mattresses

Memory Foam	10 Years Limited Warranty
Pocket Spring	5 Years Limited Warranty

The below information outlines the terms and conditions of your limited mattress warranty, it should be noted that your specific legal rights may vary from state to state.

I. PRODUCTS COVERED BY THIS LIMITED MATTRESS WARRANTY

This limited mattress warranty extends to mattresses manufactured by Aidacare Pty Ltd. ("Aidacare") under the Aspire brand, purchased directly from Aidacare or an Aspire ComfiMotion approved second party distributor located in Australia.

Mattresses are designed to work on a firm, solid and well-ventilated bed base that is structurally capable of supporting the weight of the mattress and user(s). This mattress Warranty does not cover your Product if you use it in a manner incompatible with that intended design.

II. WHO IS COVERED BY THIS MATTRESS WARRANTY?

This limited mattress warranty extends to the original purchaser of an Aspire ComfiMotion Memory Foam and/or Pocket Spring mattress who is located in Australia and complies with the products intended use. All Aspire ComfiMotion warranties, including any implied warranties, are valid only for the period of time the mattress is owned by the original purchaser of the mattress. The "original purchaser," for the purposes of this mattress warranty, is the first purchaser of the mattress from Aidacare or an Aspire ComfiMotion approved second party distributor. Please retain a copy of your receipt as proof of purchase. All Aspire ComfiMotion limited warranties are not transferable.

III. ASPIRE COMFIMOTION LIMITED MATTRESS WARRANTY AND RESPONSIBILITIES

Aidacare warrants the Aspire ComfiMotion mattresses in its original packaging sold to you against the defects in material and workmanship set forth below ("defects") for a period of:

- **10 Years** for Aspire ComfiMotion **Memory Foam** Mattress or,
- **5 Years** for Aspire ComfiMotion **Pocket Spring** Mattress

from the time your mattress is purchased by you, when the mattress is used normally for its intended purposes and on a bed base that is structurally capable of supporting the weight of the mattress and user(s).

IV. WHAT IS COVERED?

Defects covered by this limited mattress warranty **include**:

MEMORY FOAM	POCKET SPRING
<p>✓ Deterioration causing the mattress to have a visible indentation greater than 25 millimetres that is not associated with an indentation or sag which results from use of an improper or unsupportive foundation or adjustable bed base. Normal wear requires that a mattress be continuously supported by a matching foundation or adjustable bed base with a proper bed frame sufficient to support the collective weight of the mattress and foundation.</p>	<p>✓ Deterioration causing the mattress to have a visible indentation greater than 32 millimetres that is not associated with an indentation or sag which results from use of an improper or unsupportive foundation or adjustable bed base. Normal wear requires that a mattress be continuously supported by a matching foundation or adjustable bed base with a proper bed frame sufficient to support the collective weight of the mattress and foundation.</p>
<p>✓ Any physical flaw in the mattress that causes the foam material to split or crack, despite normal usage and proper handling.</p>	<p>✓ Coils or wires that protrude or have torn the fabric.</p>
<p>✓ Any manufacturing defect in the assembly of the Aspire ComfiMotion Memory Foam Classic or the Multistretch Pressure Care mattress cover that may affect the products performance.</p>	<p>✓ Coils or wires that are loose or broken.</p>

The Aspire ComfiMotion Memory Foam Mattress is strictly intended for domestic use only. This product is NOT intended for hoteling, commercial, hospital, specialised or commercial care usage, prevention or treatment of pressure injuries. It is strongly recommended to consult an Occupational Therapist and/or health professional for prescribed and specialised care solutions.

V. EXCLUSIONS

The Aspire ComfiMotion limited mattress warranty **DOES NOT** include:

A normal increase in softness of the foam pressure-relieving material or pocket spring coils which does not affect the pressure-relieving and/or supportive qualities of the mattress.

Comfort preference.

The defect is caused as a result of the product being bent, squeezed, exposed to cold temperatures or damp conditions for a period of time causing the material to tear or permanently deform.

The product has been wet, soaked or exposed to harsh climate conditions such as flooding or humidity, against Aidacare's recommendations.

The mattress or mattress cover is found to be very stained, soiled and/or otherwise unhygienic.

The product has been altered or repaired without the Aidacare's prior permission.

The use of mattress on base slats more than 75 millimetres.

Physical abuse or damage to the structure and/or cover material, including but not limited to, burns, cuts, tears, heat or liquid damage (including bleach or products containing such), or stains; provided, that the defect is caused by such abuse or damage.

Minor manufacturing anomalies that do not impact the performance of the mattress (including mis-stitching on quilting and/or the cover).

Any mattress (whether manufactured by Aidacare or not) sold by resellers who are not authorised retailers.

Mattresses sold "as-is", "preconditioned", "reconditioned", "used", "comfort return", "returned", "previously owned", or any other similar wording indicating that the mattress is not "new" or of "first quality", or has previously been purchased or used by another consumer.

In the event of a defect, Aidacare's sole and exclusive liability and your sole remedy under this limited mattress warranty will be, at Aidacare's discretion, to provide a replacement mattress or mattress cover, subject to your fulfilment of "Your Responsibilities" below. Aidacare will endeavour to replace the product from the same line. However, should the mattress or mattress cover be discontinued or unavailable, a substitute product will be issued as the replacement. The replacement mattress or mattress cover may vary in colour, style or design from the original product purchased.

VI. YOUR RESPONSIBILITIES

In the event of a defect and in order to get the benefit of this limited mattress warranty, you must return your mattresses to the original place of purchase and provide Aidacare or an Aspire ComfiMotion approved second party distributor with proof of the original date of purchase. Should shipping costs be required to return your mattress, you will not be responsible for those costs.

Evidence of a defect and any claims must be sent to place of purchase (Aidacare or an Aspire ComfiMotion approved second party distributor) before the limited mattress warranty expires.

CONSUMER WARRANTY AGAINST DEFECTS:

Aspire does not warrant against excessive or incorrect use, modification or any situation that could not be deemed as fair wear and tear. This is a back to base warranty and does not cover freight costs pertaining to the return of any items under warranty. Aspire acknowledges and conforms to all ACCC guidelines around consumer rights.

Aspire will not warrant the safety and or correct functioning of products where any original components have been changed or modified by non-Aspire approved and trained service and maintenance staff or external providers. Furthermore, safety is not guaranteed where components have been replaced with non-original Aspire approved parts. If any faults are detected upon receipt of this product please contact Aspire. Any faults that are detected during normal use should be reported to Aspire immediately to determine if warranty conditions apply and if so, the necessary repair or replacement work to be completed.

13. SERVICE LOG BOOK

Year 1 Date: _____
Service Type: _____
Condition Report: _____

Inspected by: _____ Signature: _____
Action taken: _____ Date: _____

Year 2 Date: _____
Service Type: _____
Condition Report: _____

Inspected by: _____ Signature: _____
Action taken: _____ Date: _____

Year 3 Date: _____
Service Type: _____
Condition Report: _____

Inspected by: _____ Signature: _____
Action taken: _____ Date: _____

Year 4 Date: _____
Service Type: _____
Condition Report: _____

Inspected by: _____ Signature: _____
Action taken: _____ Date: _____

Year 5 Date: _____
Service Type: _____
Condition Report: _____

Inspected by: _____ Signature: _____
Action taken: _____ Date: _____

Year 6 Date: _____
Service Type: _____
Condition Report: _____

Inspected by: _____ Signature: _____
Action taken: _____ Date: _____

Year 7 Date: _____
Service Type: _____
Condition Report: _____

Inspected by: _____ Signature: _____
Action taken: _____ Date: _____

Year 8 Date: _____
Service Type: _____
Condition Report: _____

Inspected by: _____ Signature: _____
Action taken: _____ Date: _____

Year 9 Date: _____
Service Type: _____
Condition Report: _____

Inspected by: _____ Signature: _____
Action taken: _____ Date: _____

Year 10 Date: _____
Service Type: _____
Condition Report: _____

Inspected by: _____ Signature: _____
Action taken: _____ Date: _____

AIDACARE PTY LTD

Building 3A, 1 Moorebank Avenue,
Moorebank NSW Australia 2170

1300 133 120 | aidacare.com.au

MADE IN PRC



ASUM56.35 141222