

# Liko™ MasterVest™ Mod. 60, 64

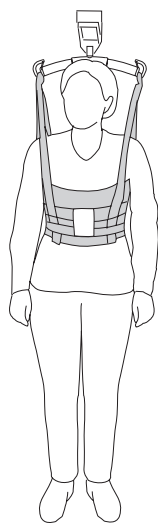

## Instructions for Use



Mod. 60

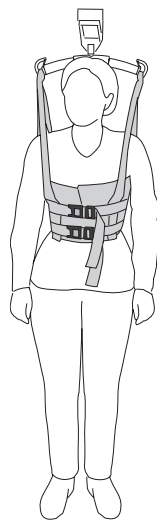

Mod. 64

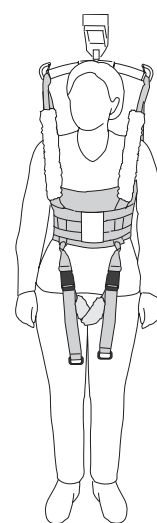

Mod. 60  
with leg harness  
and padded cases

## Product Description

Liko MasterVest is a versatile sling with a wide range of uses, for example, help with standing and walking or visiting the toilet.

MasterVest supports the patient around the upper body as well as under the arms. MasterVest requires patients to be able to partially bear weight on their legs.

Liko MasterVest enables you to reach certain difficult-to-achieve goals, for example:

- patients receive appropriate help to exercise and bear weight on their legs, and
- caregivers avoid risks associated with heavy lifting.

Lifting and transferring patients to and from the toilet can lead to severe injuries for the caregiver. MasterVest facilitates smooth and simple transfers to and from the toilet.

Since MasterVest covers only the upper body, the lower body is easily accessible for dressing and undressing.

### Front closure MasterVest, Mod. 64

The front closure model of Liko MasterVest Mod. 64 can be used for patients who are able to put on and take off the vest by themselves.

The front closure MasterVest is equipped with two adjustable safety clasps across the chest. These are also recommended in cases where it is necessary to adjust the tension and regulate pressure on the chest.

### MasterVest with Leg Harness

The leg harness holds MasterVest in place and is commonly used in walking training.

*In this document, the person being lifted is referred to as the patient, and the person helping is referred to as the caregiver.*

### IMPORTANT!





















Lifting and transferring a patient always involves a certain level of risk. Read the instructions for use for both the patient lift and lifting accessories before use. It is important to completely understand the contents of the instructions for use. The equipment should only be used by trained personnel. Ensure that the lifting accessories are suitable for the lift used. Exercise care and caution during use. As a caregiver, you are always responsible for the patient's safety. You must be aware of the patient's ability to make it through the lifting situation. If something is unclear, contact the manufacturer or supplier.

# Table of Contents

Symbol Description .....	3
Safety Instructions .....	4
Care and Maintenance .....	5
Definitions .....	5
How to Attach a Sling to Different Sling Bars.....	6
How to Attach a MasterVest to a Twin Bar.....	7
Lifting from a Seated Position.....	8
Testing the Liko MasterVest.....	9
Accessories.....	11
Overview Liko™ MasterVest™ Mod. 60, 64.....	12
Recommended Combinations.....	12

## Symbol Description

These symbols can be found in this document and/or on the product.

Symbol	Description
	Warning. Used where extra care and attention is needed.
	Read instructions for use before use
	CE mark
	Legal manufacturer
	Date of manufacturing
	Ref number
	Serial Number
	Medical device
	Do not dry clean
	Do not iron
	Tumble drying
	Do not tumble dry
	Washing Symbol is always in combination with recommended temperature in °C and °F.
	Latex Free
	Periodic inspection
	Do not bleach
	Line drying in shade
	Direction upwards and symbol on outside of equipment.
	Symbol on outside of equipment.
	GS1 Data Matrix Barcode that may contain following information. (01) Global Trade Item Number (11) Production Date (21) Serial Number

# Safety Instructions

## Before lifting, keep the following points in mind:

- A responsible person within your organization should decide on a case-by-case basis whether one or more caregivers are needed.
- Ensure that the sling selected meets the patient's needs with reference to model, size, fabric and design.
- Test the emergency lowering device on the lift you are using to make certain that it functions properly.
- Adjust the maximum height so that it will be impossible to raise a patient too high.
- For safety and hygiene reasons, use individual slings.
- Before lifting, plan the lifting operation so that it can be done as safely and smoothly as possible.
- Before lifting, check that the lifting accessory hangs vertically and can move freely.
- Although the Liko sling bars are equipped with latches, special caution must be exercised: before the patient is lifted from the underlying surface, but when the straps are fully extended, make sure the straps are correctly connected to the sling bar hooks.
- Never lift a patient higher off the underlying surface than is needed to complete the lifting and transfer procedure.
- Never leave a patient unattended during a lifting situation.
- Make sure that the wheels on the wheelchair, bed, gurney, etc., are locked during the lifting/transfer operation.
- Always work ergonomically. Use the patient's ability to actively participate in the operations.
- When the sling is not being used, do not place in direct sun light.

## Incorrect attachment of sling to slingbar may cause severe injury to the patient.

 Medical Device Class I Product

**PATENT [www.hillrom.com/patents](http://www.hillrom.com/patents)**

**May be covered by one or more patents. See above Internet address.**

The Hill-Rom companies are the proprietors of European, US, and other patents and pending patent applications.

### **Product Changes**

Liko's products undergo continuous development, which is why we reserve the right to make product changes without prior notice. Contact your Hill-Rom representative for advice and information about product upgrades.

### **Design and Quality by Liko in Sweden**

Liko is quality certified according to ISO 9001 and its equivalent for the medical device industry ISO 13485. Liko is also certified according to environmental standard ISO 14001.

### **Notice to Users and/or Patients in EU**

Any serious incident that has occurred in relation to the device, should be reported to the manufacturer and the competent authority of the Member State in which the user and/or patient is established.

## Care and Maintenance

Check the sling before each use. Check the following points with regard to wear and damage:

- Fabric
- Straps
- Seams
- Loops
- Buckles

**⚠ Do not use damaged lifting accessories.**

If anything is unclear, please contact the manufacturer or supplier.

**If the sling is used for bath or shower:** After use in bath and shower situations, the sling should be placed so that it dries as soon as possible.

**Washing Instructions:** Please see the sling's product label and the attached appendix "Care and Maintenance of Liko Slings". The safety buckles on Mod. 64 shall be closed during washing.

### Periodic Inspection

The product must be inspected at least once every 6 months. More frequent inspections might be required if the products are used or washed more often than normal. For protocols please contact your Hill-Rom representative.

### Expected Life Time

Mod. 60: The product has an expected life time of 1-5 years during normal use.

Mod. 64: The product has an expected life time of 1-4 years during normal use

Life time varies depending on the fabric, use frequency, washing procedure, and weight carried.

### Recycling Instructions

The entire sling, including laths, padding material, etc. should be sorted as Combustible waste.



Hill-Rom evaluates and provides guidance to its users on the safe handling and disposal of its devices to aid in the prevention of injury, including, but not limited to: cuts, punctures of the skin, abrasions, and any required cleaning and disinfection of the medical device after use and prior to its disposal. Customers should adhere to all federal, state, regional, and/or local laws and regulations as it pertains to the safe disposal of medical devices and accessories.

If in doubt, the user of the device shall first contact Hill-Rom Technical Support for guidance on safe disposal protocols.

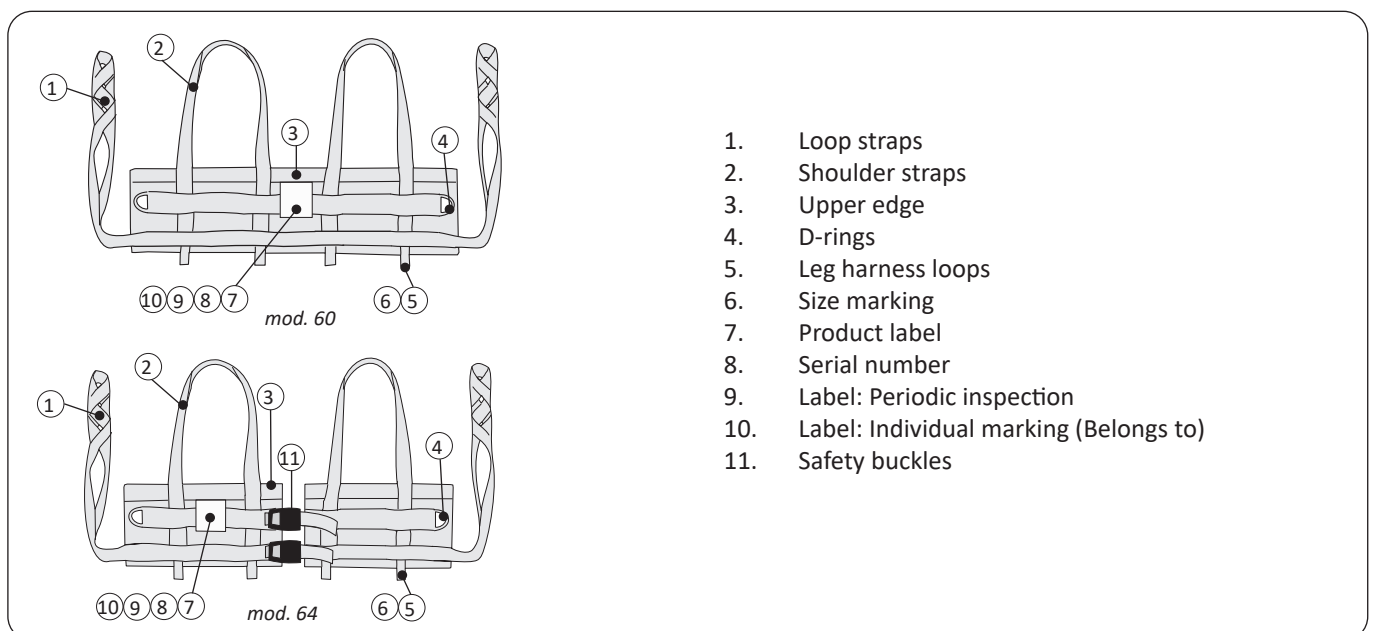
## Definitions

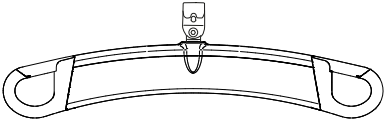
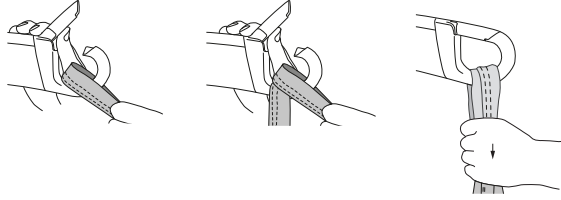
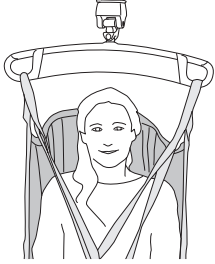
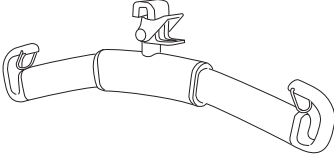
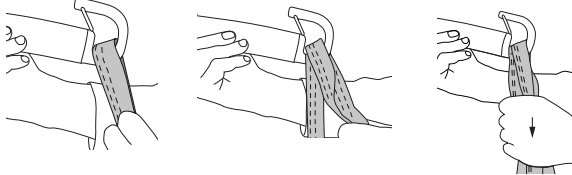

## How to Attach a Sling to Different Sling Bars

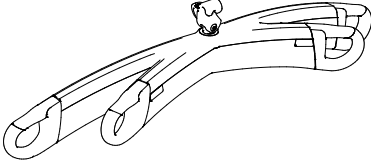
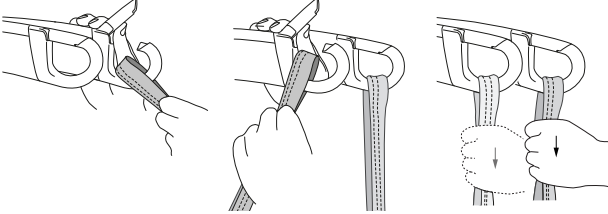
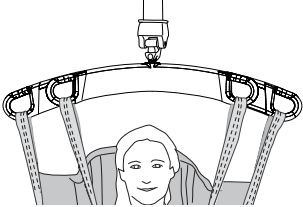
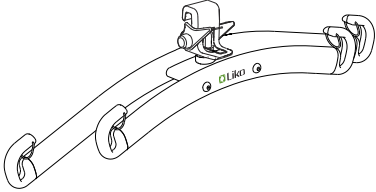
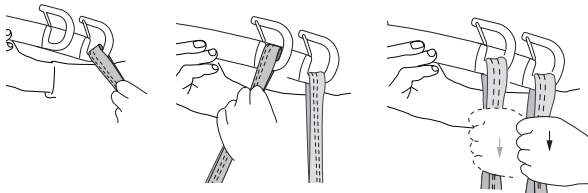
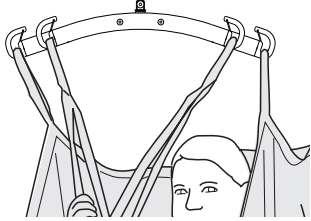
Sling bar	Sling loops to sling bar hooks	Correct
 <p data-bbox="193 495 359 528">SlingGuard™</p>		
 <p data-bbox="213 788 338 822">Universal</p>		
 <p data-bbox="161 1070 394 1104">SlingGuard™ Twin</p>		
 <p data-bbox="177 1368 370 1402">Universal Twin</p>		

### Wrong!

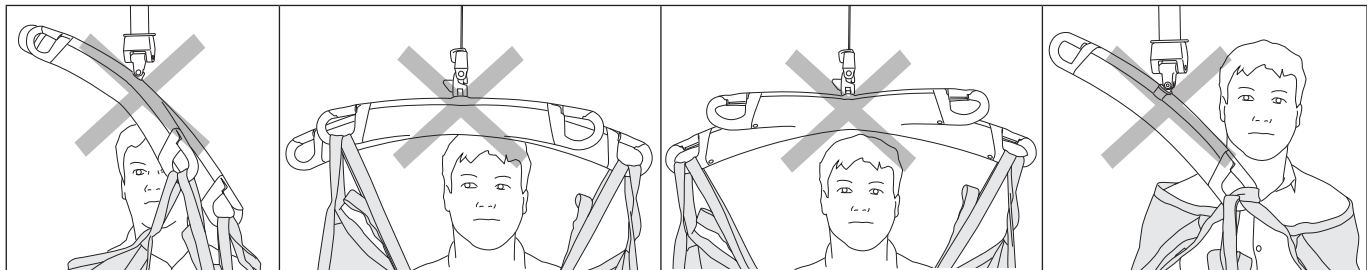

# How to Attach a MasterVest to a Twin Bar

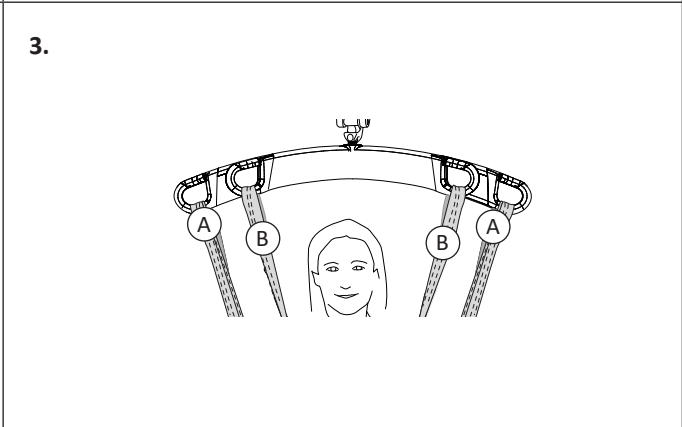
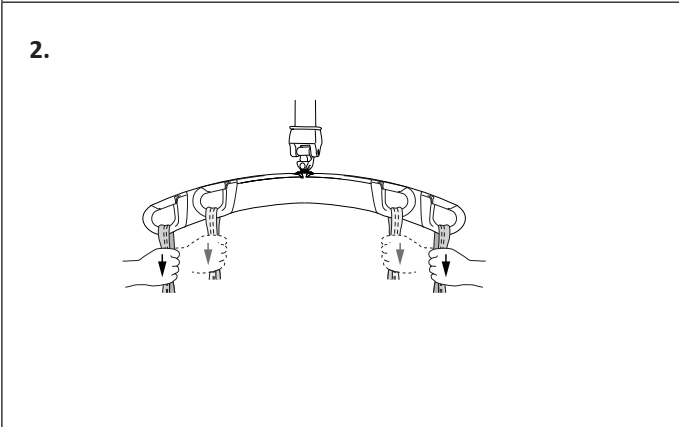
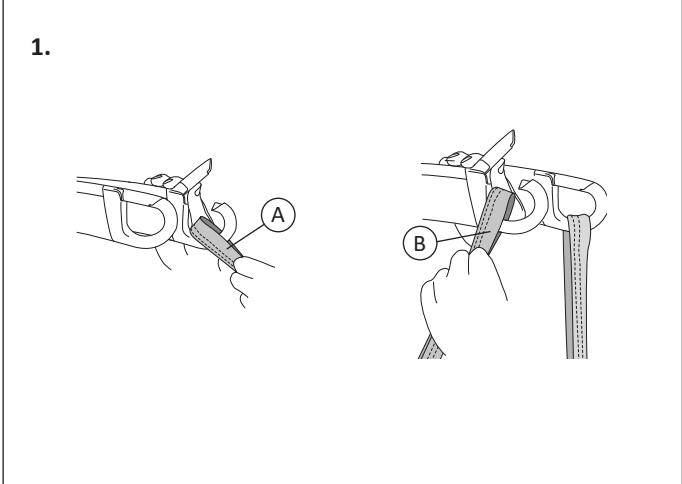
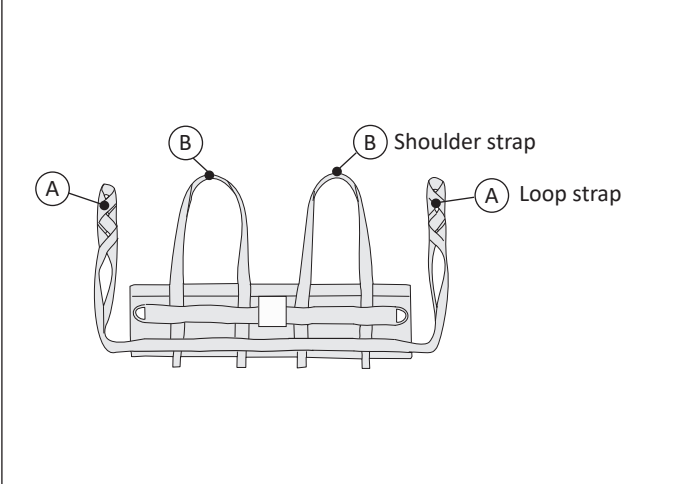

## Lifting from a Seated Position

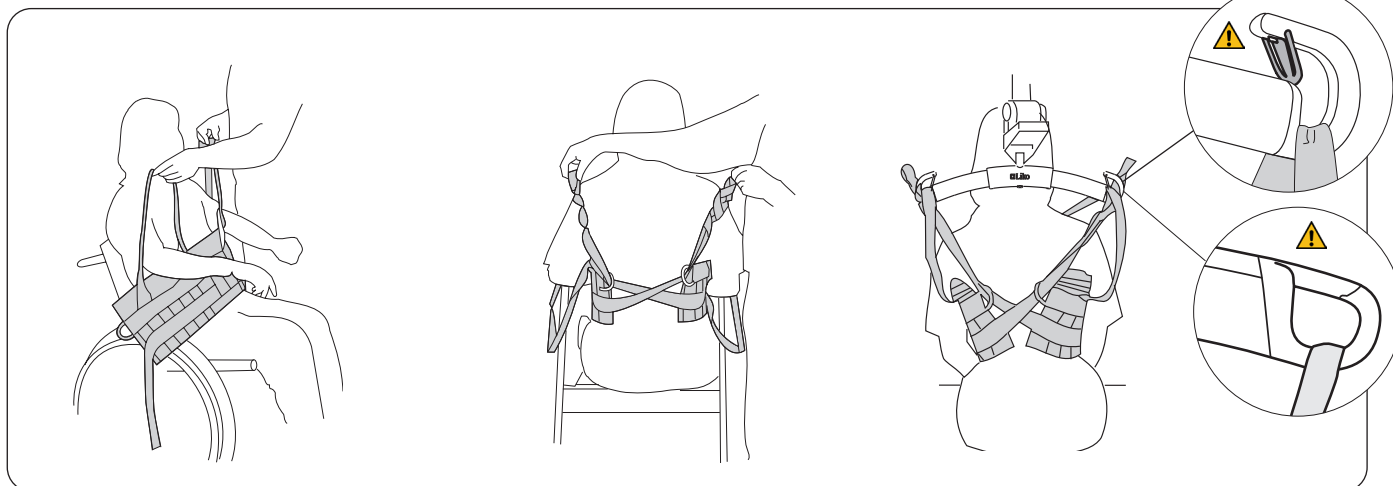

Put on MasterVest from the front. The patient's arms are placed through the shoulder straps.

Behind the back: Draw each loop strap across the back and pull it through the metal D-ring on the opposite side, as shown in the illustration.

With the sling bar behind the patient's back, attach the loop straps, using a suitable loop, see page 9-10. Attach the shoulder straps to the sling bar. See page 6-7 for instructions on how to attach the sling loops to different sling bars.

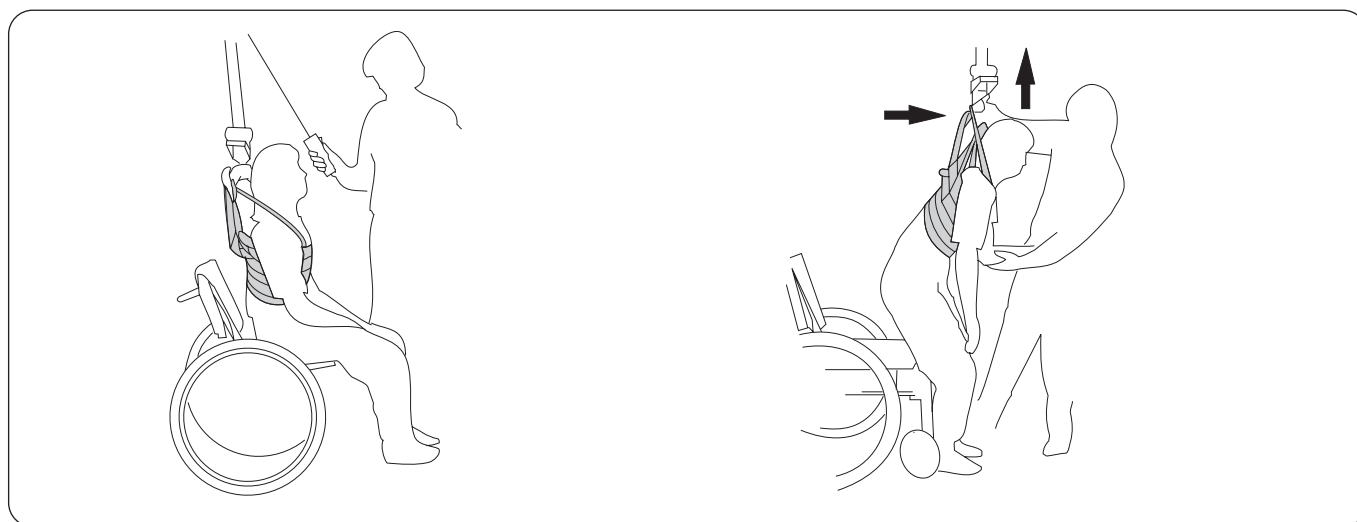

**Before lifting:** Check that the patient's feet are solidly on the floor so that he/she can bear weight as the sling bar is raised. Raise the sling bar slightly to tighten the straps (without lifting the patient off the seat), and check that the pressure distribution around the patients upper body feels correct.

**During the lift:** Pull the sling bar forward so the patient's weight is transferred smoothly until he/she stands upright and in balance. Lower the sling bar slightly to relieve pressure around the chest. Now the patient has an opportunity to put weight on the legs and work on balance training.



# Testing the Liko MasterVest

## Selecting the Right Size

For MasterVest to function properly, the width of the vest must be in correct proportion to the circumference of the patient's upper body. Therefore, it is important to select the right size and carefully determine the correct loop on the loop strap.

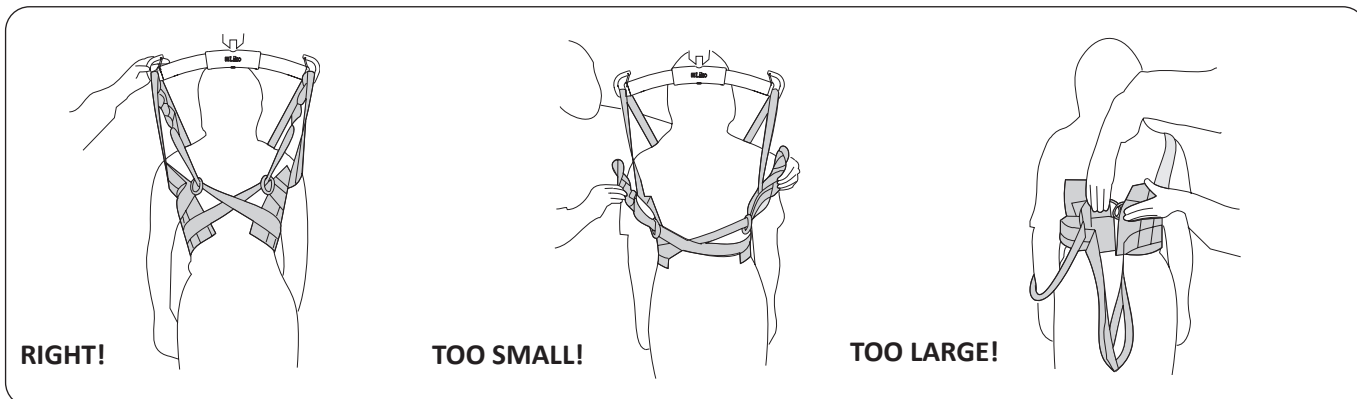

The size is right when the gap between the metal D-rings is between 5 cm (2 inch.) and 30 cm (12 inch.). The larger the size of the vest, the wider the gap can be.

The size is too small when the gap between the metal D-rings is too wide, the loop straps do not reach up to the sling bar, and the pressure around the chest is too great.

The size is too large when the metal D-rings touch. The vest is too wide and does not tighten during lifting but slides upward. A vest that is too large creates too much pressure under the armpits.

## Adjusting the Loop Straps

The loop which you hook onto the sling bar determines how much the vest tightens around the chest.

If the vest slides upward - try an inner loop or a smaller size of the vest.

If the vest fits too tightly around the chest - try an outer loop or a larger vest size.

If two different people try the same size, the slimmer person would need an inner loop while a bigger person would need an outer loop. The MasterVest is correctly adjusted when the shoulder straps and loop straps are equally taut when lifting the patient.

## Testing the Loop Straps

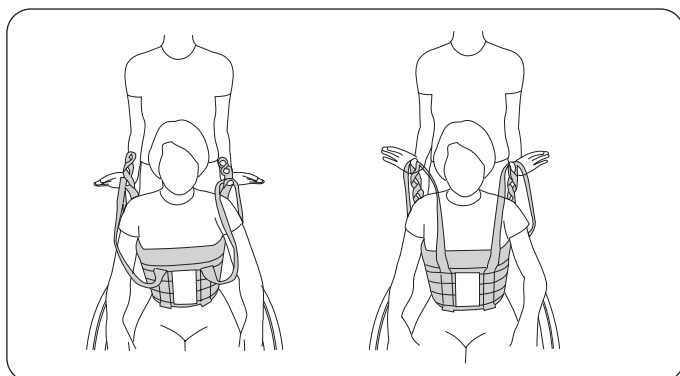

To find which loops give the best fitting, test the loop straps by drawing on different loops along with the shoulder straps.

To test for the correct fitting of the loop straps, stand behind the patient and suspend the shoulder straps and loop straps from your thumbs and lift upward until the straps are taut. The MasterVest fits correctly when the loop straps and shoulder straps are equally taut when lifted.

## Loop Clips

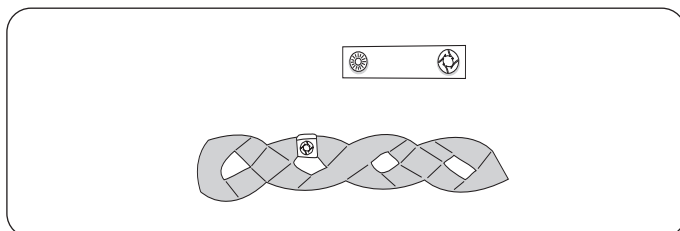

This practical accessory is used to mark the loops that have been tried out for a certain person. It makes it easier for the caregivers to choose the right loop to attach to the sling bar.



## Body Posture

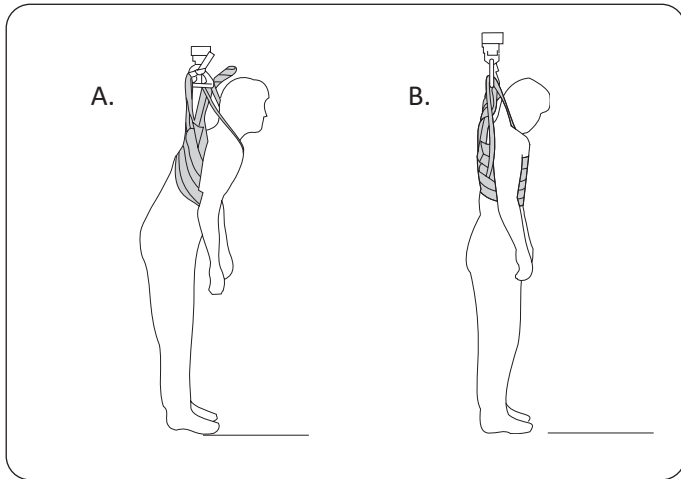

An individual may often fit into two different sizes of the MasterVest, but the loop straps must be correctly adjusted to each size. The results differ regarding body posture and pressure distribution around the chest.

A. A larger MasterVest size requires you to use one of the inner loops on the loop strap. This fitting allows the patient to bend forward, and places more pressure on the lower front part of the chest.

B. A smaller MasterVest size requires you to attach one of the outer loops of the loop strap to the sling bar to obtain equal tension on all four straps. In this case, body posture is more upright and pressure is more evenly distributed around the chest.

## Front closure MasterVest, Mod. 64

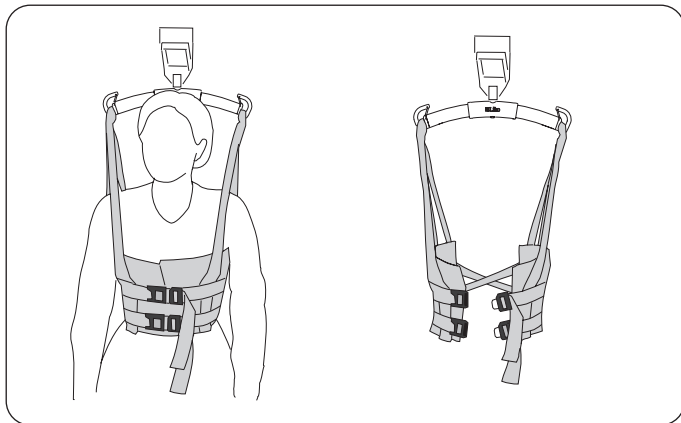

The MasterVest is also available in a front closure model.

The front closure MasterVest is equipped with two adjustable safety buckles in front. Test for the correct vest size and position of the loop straps even when patients themselves put on the MasterVest. After the MasterVest has been correctly adjusted, it can hang from the sling bar while the patient puts it on.

## Liko MasterVest in Plastic-coated Net

The most common sizes of the MasterVest are available in plastic-coated net. Friction from the material counteracts the tendency of the vest to slide upward. A MasterVest in plastic-coated net may also be used for bathing.

## Problem during Testing?

**Problem:** The vest slides up under the patient's arms.

Adjust the MasterVest using one or more of the following suggestions:

- Adjust the loop strap by using an inner loop.
- Choose a smaller size.
- Try using a Liko MasterVest of plastic-coated net.
- Try using the leg harness.
- Hold the vest in place behind the back while raising the patient by pressing your thumb downward on the crossed loop straps.
- Have the patient keep his/her arms down while lifting.

# Accessories

## Leg Harness

Prod. No. 3666004-06

A special leg harness can be used with the Liko MasterVest to help keep the vest from sliding up on the body. The harness can be put on while the patient is sitting, and after lifting the patient you can adjust the position and tension of the harness. The harness straps may be crossed or parallel through the crotch.

NOTE! The leg harness fits vests from serial number 736166. Contact your Hill-Rom representative for more information on earlier models.

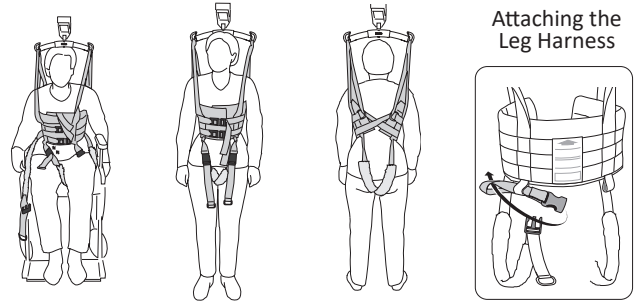

## Padded Case for Shoulder Strap

Prod. No. 3666021

Padded cases are available as an accessory to help relieve pressure on the front shoulder straps.

Padded cases are equipped with Velcro along one side for easy application.

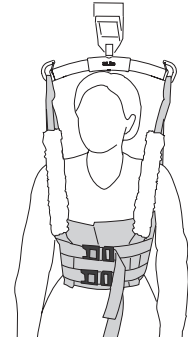

## Loop Clips

- Loop Clips, red, 4 pcs
- Loop Clips, orange, 4 pcs
- Loop Clips, yellow, 4 pcs
- Loop Clips, blue, 4 pcs
- Loop Clips, black, 4 pcs

- Prod. No. 3666033
- Prod. No. 3666034
- Prod. No. 3666035
- Prod. No. 3666036
- Prod. No. 3666037

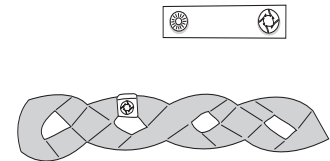

## Extension Loop

- Extension Loop, green, 12 cm (5 in)
- Extension Loop, green 22 cm (9 in)
- Extension Loop, grey, 12 cm (5 in)
- Extension Loop, grey, 22 cm (9 in)

- Prod. No. 3691102
- Prod. No. 3691103
- Prod. No. 3691302
- Prod. No. 3691303

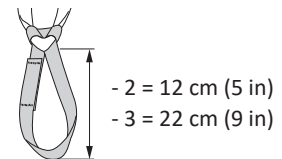

# Overview Liko™ MasterVest™ Mod. 60, 64

Product	Prod. No.	Size	Body Weight kg <sup>1</sup>	Maximum load <sup>2</sup>
MasterVest Mod. 60	3560113	XS	20-40 kg (44-88 lbs.)	200 kg (440 lbs)
MasterVest Mod. 60	3560114	S	40-60 kg (88-132 lbs.)	200 kg (440 lbs)
MasterVest Mod. 60	3560115	M	60-80 kg (132-176 lbs.)	200 kg (440 lbs)
MasterVest Mod. 60	3560116	L	80-100 kg (176-220 lbs.)	200 kg (440 lbs)
MasterVest Mod. 60	3560117	XL	100-130 kg (220-286 lbs.)	300 kg (660 lbs.)
MasterVest Mod. 60	3560118	XXL	>120 kg (>264 lbs.)	300 kg (660 lbs.)
MasterVest Mod. 64	3564114	S	40-60 kg (88-132 lbs.)	200 kg (440 lbs)
MasterVest Mod. 64	3564115	M	60-80 kg (132-176 lbs.)	200 kg (440 lbs)
MasterVest Mod. 64	3564116	L	80-100 kg (176-220 lbs.)	200 kg (440 lbs)
MasterVest Mod. 64	3564117	XL	100-130 kg (220-286 lbs.)	200 kg (440 lbs.)
MasterVest Mod. 64	3564118	XXL	>120 kg (>264 lbs.)	200 kg (440 lbs.)

<sup>1</sup> The indicated patient weight is a guideline only – there may be deviations.

<sup>2</sup> To maintain maximum load, lift/accessories intended for the same load or more are required.

**Material:** MasterVest is available in Polyester.

## Recommended Combinations

Recommended combinations using Liko MasterVest with Liko sling bars:	Mini 220	Sling bar 350 <sup>3</sup>	Standard 450	Sling bar 450 <sup>1</sup>	Sling bar 600 <sup>4</sup>	Twin bars 670 <sup>2</sup>
	MasterVest, XS	1	1	2	1	3
MasterVest, S	2	1	1	1	3	4
MasterVest, M	2	1	1	1	3	4
MasterVest, L	2	1	1	1	3	2
MasterVest, XL	3	1	1	1	2	2
MasterVest, XXL	3	2	1	1	2	2

<sup>1</sup> Sling bar 450 relates to Universal SlingBar 450 Prod. No. 3156075, 3156085, and 3156095, and also SlingGuard 450 Prod. No. 3308020 and 3308520.

<sup>2</sup> Twin bars 670 relates to Universal TwinBar 670 Prod. No. 3156077, and 3156087, and also SlingGuard 670 Twin Prod. No. 3308040 and 3308540.

<sup>3</sup> Sling bar 350 relates to Universal SlingBar 350 Prod. No. 3156074, 3156084, and 3156094.

<sup>4</sup> Sling bar 600 relates to Universal SlingBar 600 Prod. No. 3156076 and 3156086.

**Explanation:** 1 = Recommended, 2 = May work, 3 = Not advised, 4 = Inappropriate

Different sling bar widths create different levels of pressure on the chest. Try various alternatives until you find the one best suited to the individual patient.

## Other Combinations

Combinations with Liko MasterVest and Cross-bar, Cross-bar 450/670 or Side bars is not appropriate.

Combinations of accessories/products other than those recommended by Liko can result in risks for the safety of the patient.



[www.hillrom.com](http://www.hillrom.com)

Liko AB  
Nedre vägen 100  
975 92 Luleå, Sweden  
+46 (0)920 474700

Liko AB is a subsidiary of Hill-Rom Holdings Inc.

Enhancing outcomes for patients and their caregivers:

